

vilo

---

Decorative walls, floors, facades

---

Comprehensive offer

---

The Vilo brand stands for products that combine good design, ease of installation and affordable price.

This makes them an ideal offer for price-sensitive customers who do not want to give up interesting design. They are an alternative to expensive arrangement projects and long renovations.

The Vilo brand portfolio includes decorative walls, windowsills, doors, floors, skirting boards and facade coverings.





Decorative walls



SPC wall panels



Motivo decorative wall



Upholstered panels



Windowsills



SPC wall panels

SPC wall panels are a modern solution for a quick and easy interior transformation. Thanks to waterproof construction, they are suitable for spaces exposed to moisture, such as kitchens and bathrooms, and in areas with fluctuating temperatures. Made with SPC (Stone Polymer Composite) technology, the panels feature a durable, scratch-resistant composite core, coated with a decorative, UV-resistant layer. The click installation system guarantees easy installation without the need for grouting. The panels are available in the formats 30x60 cm and 60x120 cm.



# Key features



## Waterproof

The panels are easy to install, ideal for new builds or renovations, and can be applied to various surfaces, including ceramic tiles, without requiring specialized tools.



## Impact resistant

The panels are highly durable and resistant to damage, and do not deform under impact, guaranteeing a long-term aesthetic and functionality.

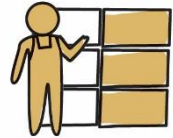

## Quick renovation

Fast adhesive allows you to enjoy your new interior quickly. Unlike ceramic tiles, the panels do not dust when cut, so can be fitted precisely to any shape without time-consuming cleaning.



## Easy installation

Easy to install, perfect for new construction or renovation projects, and can successfully be installed on a variety of surfaces, including ceramic tiles.

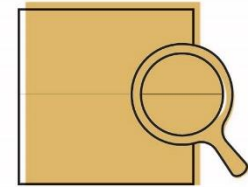

## No grouting

They do not require grouting – thus avoiding areas potentially exposed to mould and mildew.



# Decors



Calacatta Snow

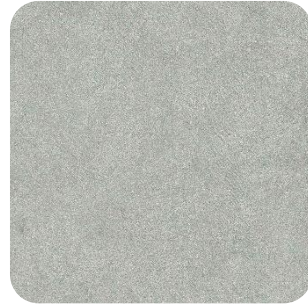

Concrete Light



Concrete Dust



Concrete Beige



Rusty



Calacatta White



Ash Grey



Marble Skin



Dark Stone



Calacatta Black



# Technical informations

- Protective UV lacquer
- Decorative layer
- SPC composite core

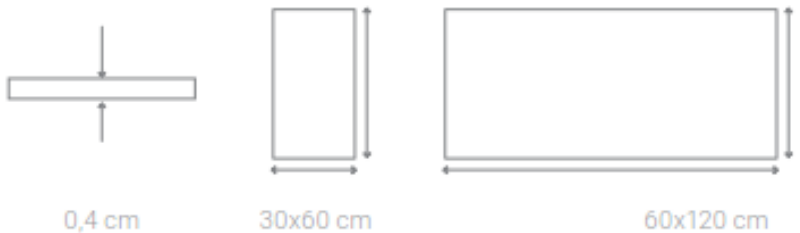
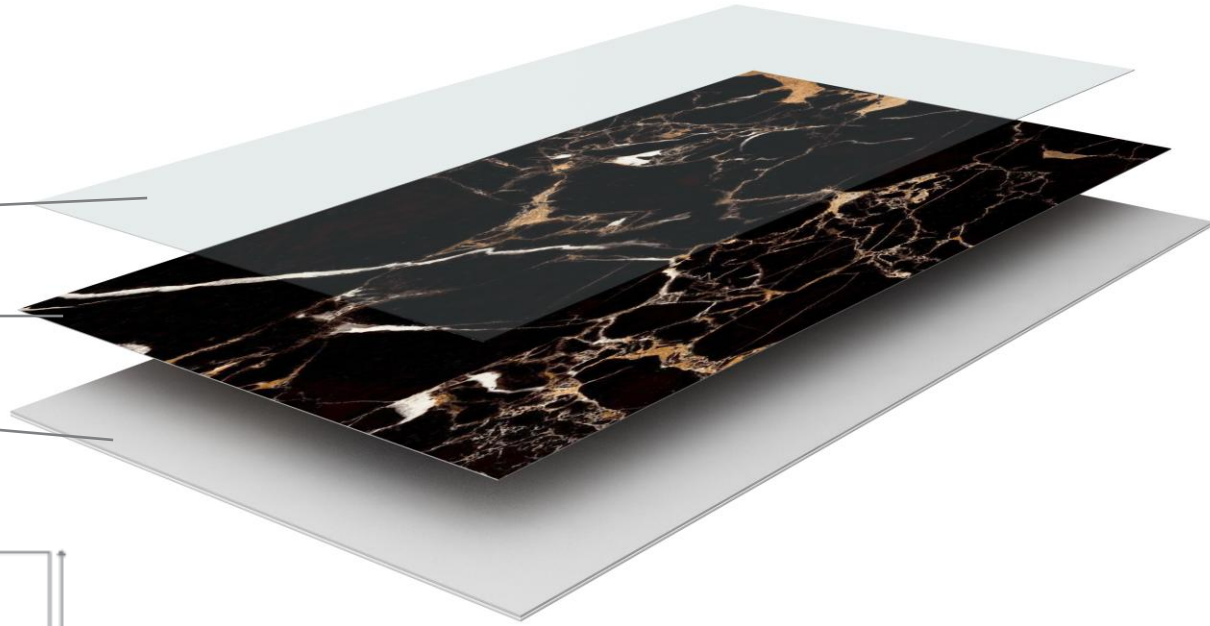

Motivo decorative wall



---

Motivo decorative wall offer an efficient solution for quick interior renovation. The panels can be easily installed by gluing them directly to the wall. With their water-resistant surface, they are ideal for kitchens and bathrooms. Easy to install without the need for professional support..



# Key features



## Waterresistant

The panels are completely water-resistant, do not absorb moisture and do not change volume after contact with water. They can be used in rooms with high humidity.

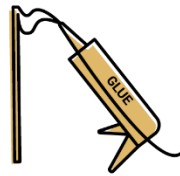

## Installation on glue

Panels can be installed using adhesive. Apply mounting adhesive to the panel and press directly to the wall for a durable result without the need for additional tools.



## Easy to clean

To clean the panels, simply wipe the surface with a damp cloth or mild detergent..



## Easy installation

Installing the panels is quick and easy. No special tools are required for a quick interior makeover. The intuitive installation system makes it possible to renovate the room yourself.



# Decors



Natural Plank  
B608, B617, B619



Light Wood  
B603, B615



Grey Wood  
B603, B615



Colour Wood  
B603, B615, B618



Coffee Wood  
B604, B616, B619



Carmel Wood  
B617, B618



Natural Wood  
B607, B615, B619



Selva  
B604, B607, B619



Nutmeg Wood  
603, 618



Toffy Wood  
B604, B618, B619

# Decors



Whitewash Wood  
B601, B615, B618



Ashy Wood  
B617, B618, B621



Fun Wood  
B601, B603, B615



Smoky Wood  
B615, B617, B618



Reclaimed Wood  
B604, B607, B609



Light Lamella Small  
B607



Light Lamella Medium  
B607





# Decors



Sky Marble  
B601



Gold Marble  
B603



Crema Stone  
B601



Sunny Stone  
B601



White Marble  
B603



Carrara Marble  
B601, B603, B615,  
B618



Grey Marble  
B601, B603, B615,  
B617



Winter Stone  
B603



Winter Marble  
B601, 603



Twine Grey  
B603, B615, B618

# Decors



Carrara Tiles  
B603

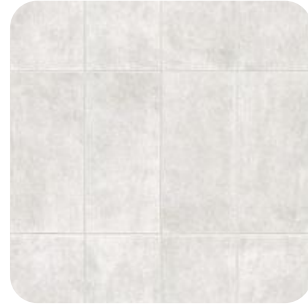

Misty Marble  
B602, B603



Beige Marble  
B604



Graphite  
B601, 603, 618



Sandstone Tiles  
B604, B615



Honey Marble  
B615, B618



Biscuit Marble  
B603, B604, B609,  
B620



Brown Marble  
B604, B609, B618



Dark Stone  
B601, 603, 618

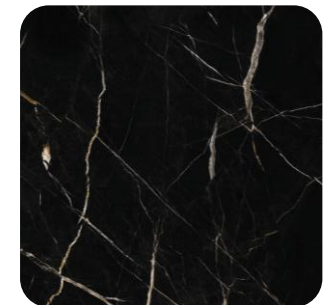

Calacatta Black  
B604, B615





# Decors



White Brick  
B601, B615, B618



Loft Bick  
B601, B603



Rusty Brick  
B609, B619, B621



Vintage Brick  
B603



Blue Brick  
B619



Ornament Brick  
B601, B615, B617,  
B618



Street Brick  
B601, B603, B617



Old Brick  
B615, B617, B618



Red Brick  
B615



Narrow Brick  
B615, B617, B618

# Decors



Concrete Gris  
B603

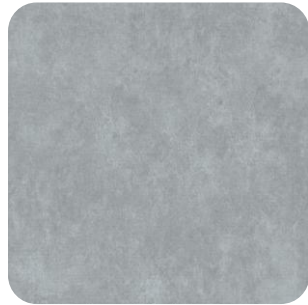

Concrete Style  
B603

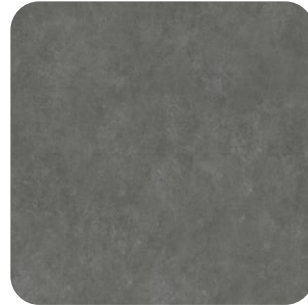

Concrete Grigio  
B603



Dusky  
B615, B618



Sheer  
B603, B615, B618



Askot Grey  
B601, B603, B604,  
B618



Warm Concrete  
B604



Sandstone Beige  
B



Concrete Forest  
B603; B615



Newspaper  
B602, B604, B609,  
B619



# Decors



Piedra  
B615, B617

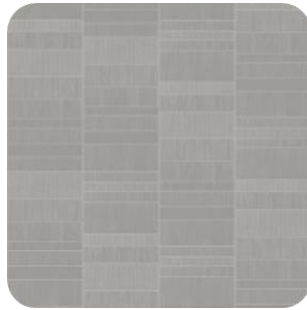

Silver Decor Tiles  
B603, B618

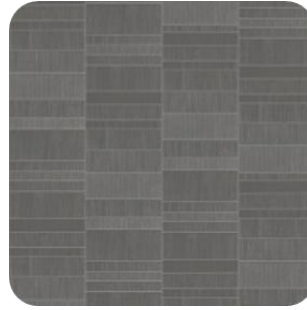

Graphite Decor Tiles  
B615, B617, B618

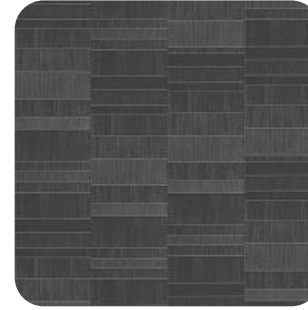

Anthracite D. Tiles  
B615, B617, B618



Corteen  
B615, B619



Piedra Pastello  
B615



Silver Tiles  
B603, B618



Graphite Tiles  
B615, B617, B618



Anthracite Tiles  
B615, B617, B618



Newspaper  
B602, B604, B609,  
B619

# Decors



Daisy  
B601 B603, B618



Marble Mosaic  
B601, B602, B603



Colour Cubes  
B615, B618



Taupe Leaves  
B601, B603



Arenoso  
B604



Piedra Pastello  
B615



Orient  
B602, B609, B617,  
B619



Desert Wave  
B602, B604, B605,  
B615



Ecoline



Tulip  
B601



# Technical informations

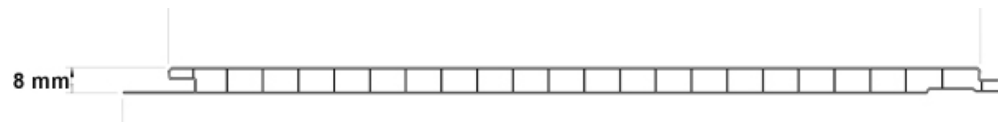
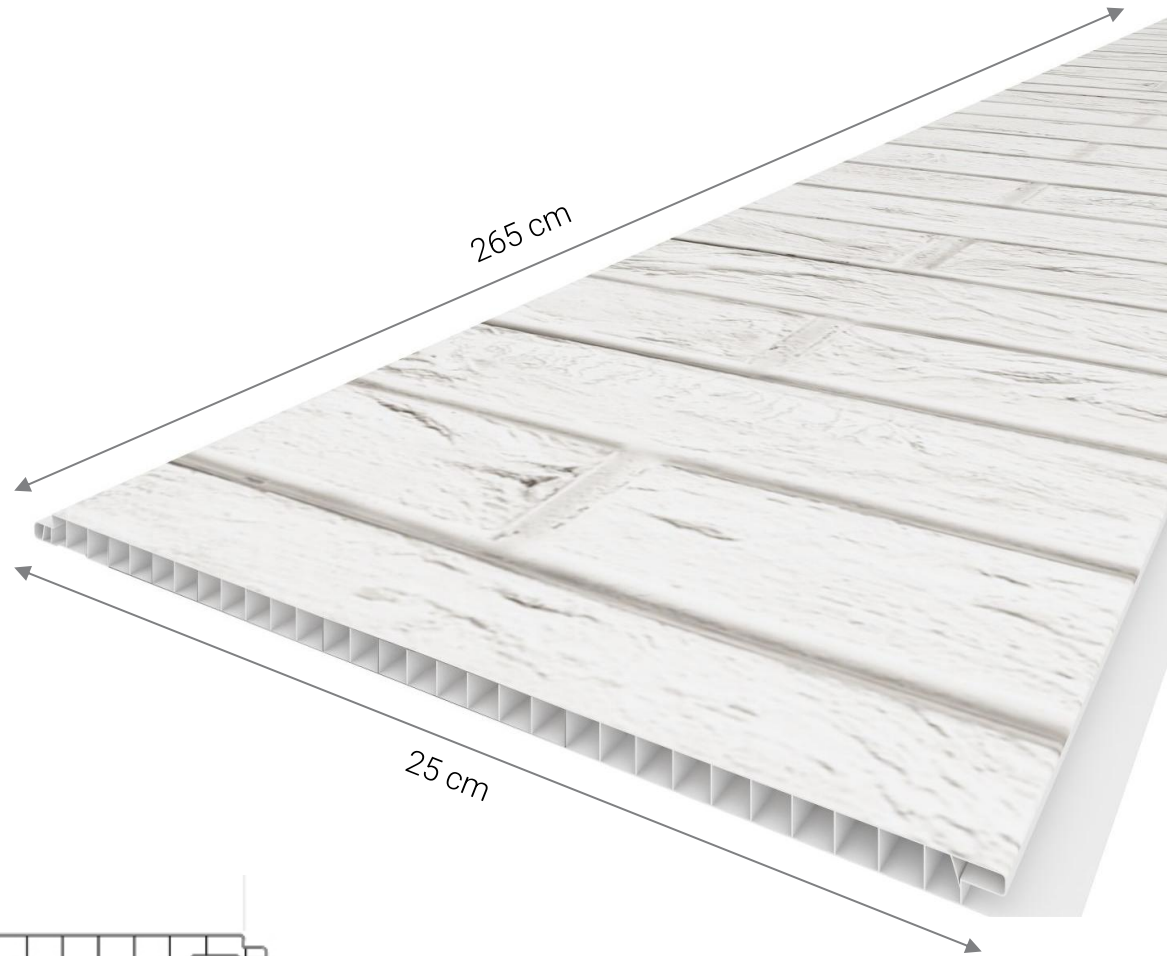



# Universal finishing trim Vilo B6

Self-adhesive Universal finishing trim B6 is the perfect solution for finishing Motivo panels (as a corner or at the end of the panel). Wide range of colours helps to match the trim ideally. Trim B6 is 300 cm long (5 cm x 300 cm).



B601



B602



B603



B604



B605



B606



B607



B608



B609



B615



B616



B617



B618



B619



B620



B621

# Dedicated trim Vilo B1-B5

Inflexible finishing trims dedicated for a specific application. The trims have a new length (2.7m) and modified dimensions, allowing for more subtle finish to the wall with Motivo panels.



B1  
External angle

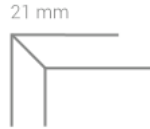

B2  
Universal trim U

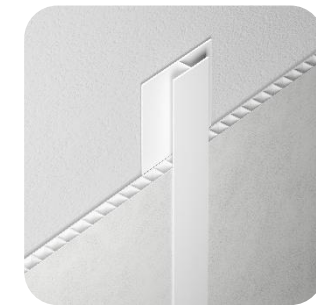

B3  
Joint



B4  
Top edge  
(only in white)

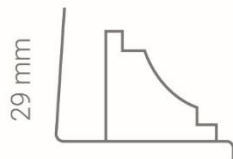

B5  
Internal angle

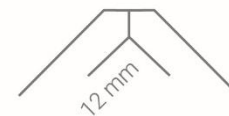

# Dedicated finishing trim Vilo B1-B5

These types of trims are dedicated to a specific application when assembling Motivo walls, e.g. connecting with the ceiling.  
Trims B1-B5 are 270 cm long.



White



Grey



Silver



Mocca



Olive



Birch



Pine

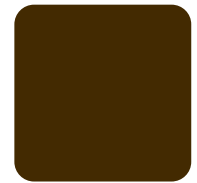

Light Brown

\* these colours are dedicated for B1, B2, B3, B5

\* B4 trim only in white colour



Sand



Beige



Mint



Green bottle



Graphite

\* these colours are dedicated for B2, B3, B5



Upholstered panels

Upholstered panels are a decorative way of finishing interiors. Made from soft materials, they combine aesthetics with functionality. Available in a variety of colours and shapes, they can be easily adapted to suit any design style. They also help to soundproof a room and provide comfort for the user. A simple and stylish solution to refresh walls and give them a pleasant, soft touch.



# Key features



## Quick installation

The panels are easy and quick to install. No special tools or skills are required, just glue. It is easy to install on the wall and can be combined with other elements from different collections

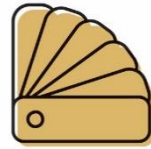

## Wide range of colours

The fabric colors for upholstered panels have been carefully chosen to allow endless combinations. Saturation and range enhancing the character of interior.



## Soft to the touch

Upholstered panels are exceptionally soft and pleasant to the touch. This is achieved by using high quality fabrics and carefully selected fillings..

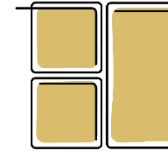

## Horizontal and vertical installation

The installation options offer the flexibility to choose between vertical and horizontal orientation, depending on the selected shape.



## Design

The panels can be easily installed on your own, and the room is ready to use immediately after installation. Vertically or horizontally installation possible, depending on the chosen shape.



# Product range

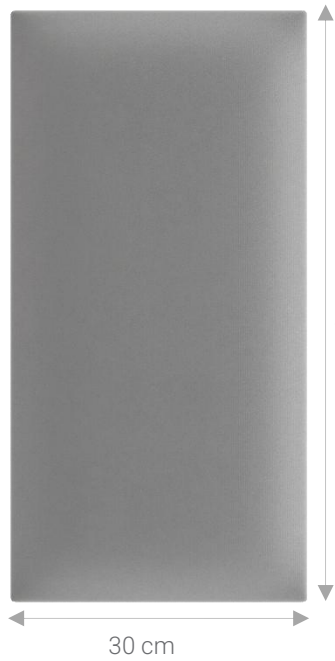

Regular 1

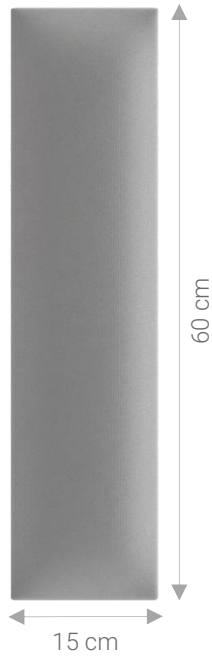

Regular 2

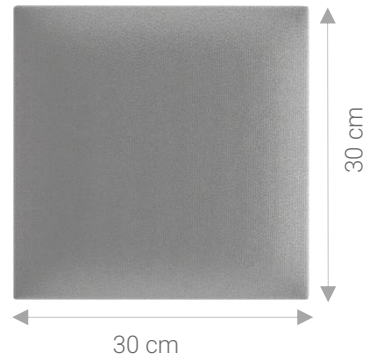

Regular 3

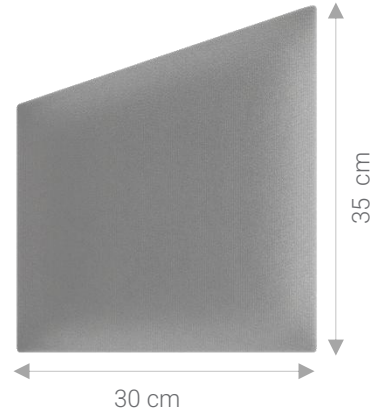

Geo

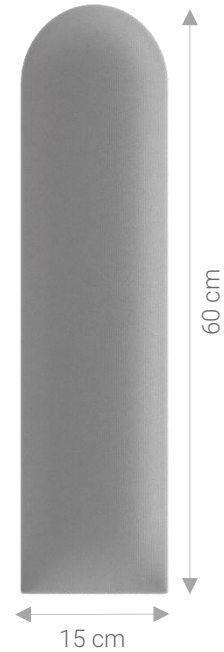

Oval

---

## Colour range



Grey



Blue Sea



Powder Pink



Mustard



Oval



Bottle Green



Navy Blue



Graphite



Black

# Panel construction

- Fabric  
Pleasant and soft to the touch, similar to velvet and plush.
- Foam  
Made of flexible, dense polyurethane foam that gives it the right shape.
- Back of the panel  
6 mm thick MDF.



# Examples of configuration:

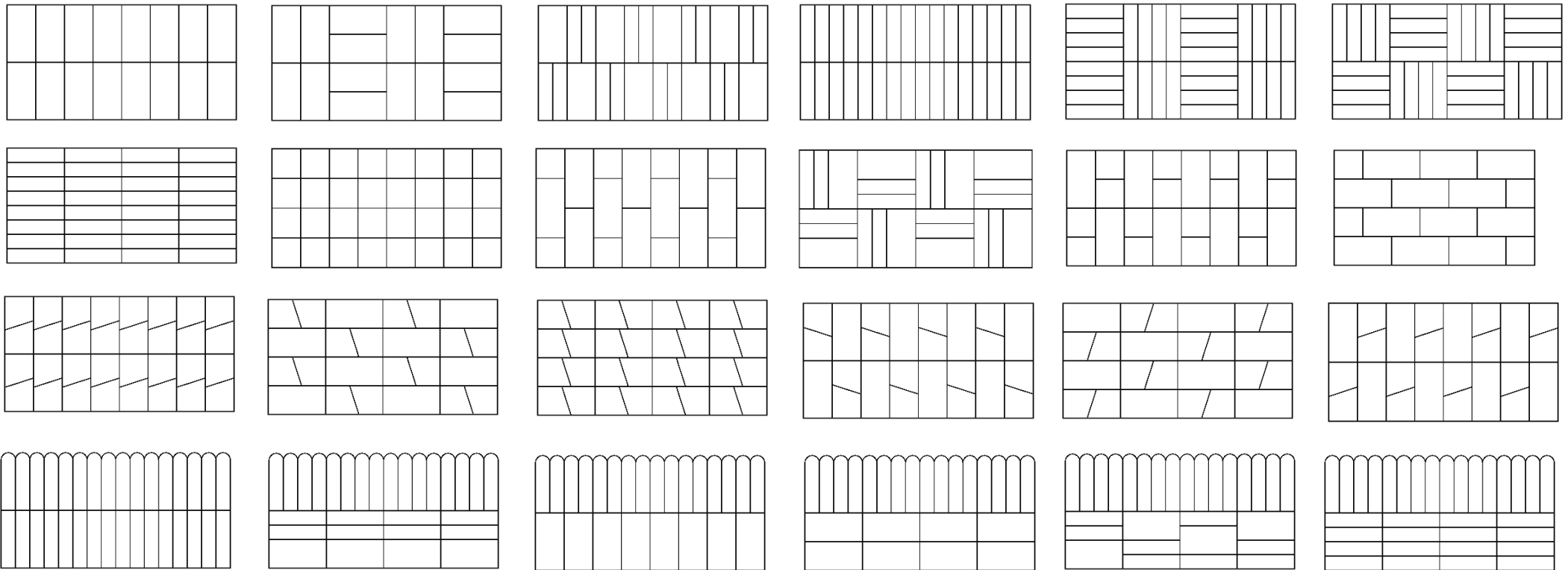

A close-up photograph of a dark-stained wooden windowsill. The sill is mounted on a light-colored wall. On the sill, there are two potted plants: a fern in a black pot and a spiky plant in a grey pot. Below the sill, a white radiator is visible. To the right, a white cabinet with a dark wood top holds two more potted plants in white pots. The window frame is made of dark wood and is visible in the upper left.

Windowsills

In the Vilo windowsill range there are two solutions available - chamber windowsills and windowsill overlay.

Vilo windowsills are the perfect solution for renovating old windowsills. They are highly resistant to moisture and UV radiation, making them a durable and practical window finish. High-quality veneers ensure scratch resistance, while the smooth surface makes them easy to keep clean. The windowsill overlay allows for the renovation of damaged or difficult to replace windowsills without the need for removal.



# Key features



## Quick installation

The installation is quick, simple, and effortless. Simply adjust the dimensions, cut the windowsill to size, and install it with adhesive.



## Easy installation

Installation is simple and does not require specialized tools. It is the ideal solution for many situations, depending on your needs.



## Easy to clean

Use mild detergents such as warm water with washing-up liquid to keep windowsills clean without risking damage to the surface.



## Impact resistant

The windowsills are made from a material resistant to mechanical damage, scratches and water. The use of high-quality veneers protects them from the effects of sunlight..



---

## Colours



White



Marble

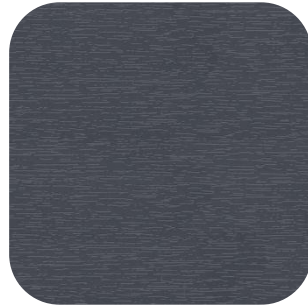

Anthracite \*



Oak Winchester



Golden Oak



Walnut

The same colours are available for windowsills and windowsill overlays

\* Anthracite only for windowsills in certain sizes

# Technical informations

Chamber windowsill

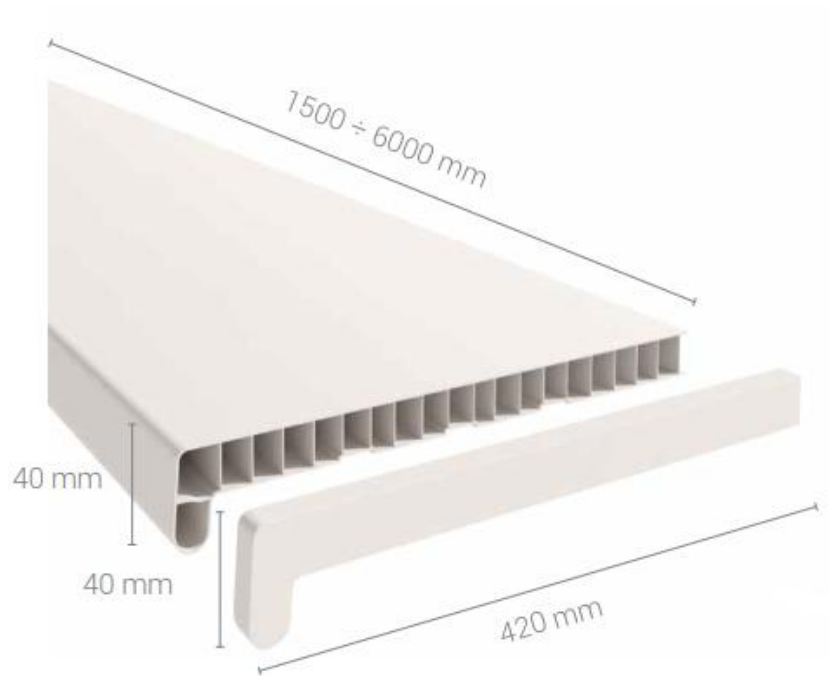

Windowsill overlay

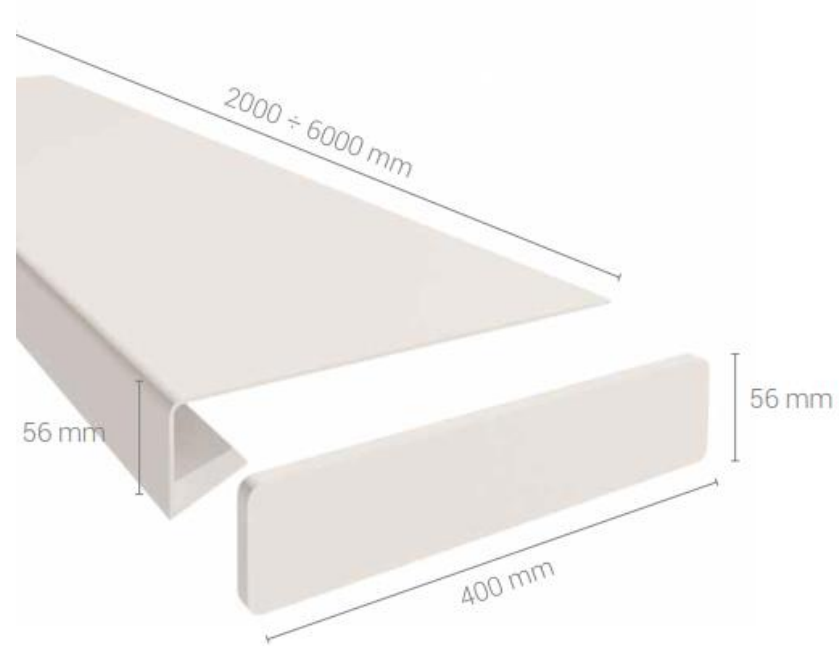

# Technical informations

Vilo windowsills are provided with end caps in corresponding colour.

## Chamber windowsill



White

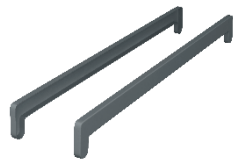

Anthracite



Winchester



Golden Oak



Walnut

## Windowsill overlay



White



Winchester



Golden Oak



Walnut

# Technical informations

Type of windowsill	Width mm 	Length mm 	Colour					
			Anthracite	White	Marble	Nut	Winchester	Golden Oak
Chamber windowsills	100	6000		●	●			
	150			●	●	●	●	●
	200			●	●	●	●	●
	250			●	●	●	●	●
	300			●	●	●	●	●
	350			●	●	●	●	●
	400			●	●	●	●	●
	480			●	●			
Windowsill overlays	380			●	●	●	●	●

Type of windowsill	Width mm 	Length mm 	Colour					
			Anthracite	White	Marble	Nut	Winchester	Golden Oak
Cover caps for chamber windowsills		420		●		●	●	●
Cover caps for windowsill overlays		400		●		●	●	●
Chamber windowsills cut to size (including cover cap)	250	1500	●	●	●	●	●	●
		2000	●	●	●	●	●	●
		2500		●	●	●	●	●
	300	1500	●	●	●	●	●	●
		2000	●	●	●	●	●	●
		2500		●	●	●	●	●
Windowsill overlays cut to size (including cover cap)	380	2000		●	●	●	●	●
		3000		●	●	●	●	●



# Floors and complementary products



SPC Wood flooring



SPC Stone flooring



Skirting boards  
Sempla, Linela, Esquero, Esquero Duo,  
Izzi, Flex

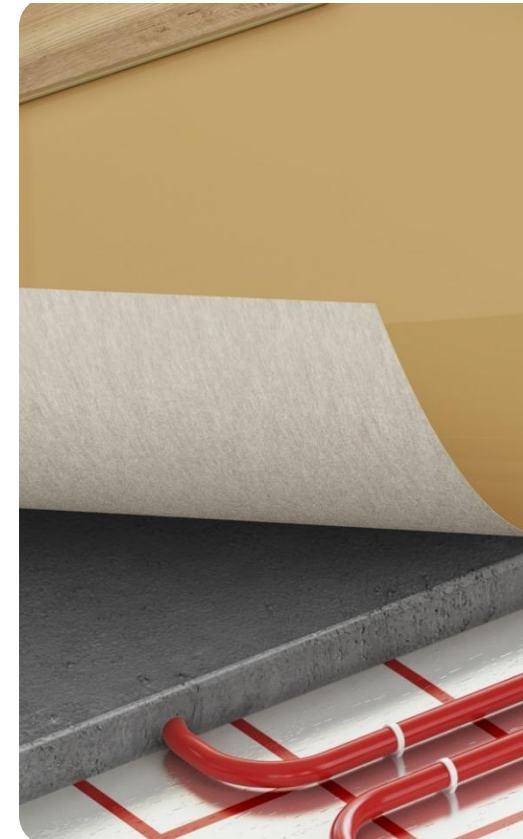

Underlays



SPC Wood flooring

---

SPC Wood flooring is an innovative solution that combines durability, aesthetics, and functionality. The rigid core and UV-cured coating make the vinyl panels highly resistant to scratches, stains, and heavy loads. Waterproof and slip-resistant surfaces ensure the flooring is ideal for high-humidity areas such as kitchens and bathrooms. The Click system allows for quick and easy installation without the need for specialized tools. A wide range of oak-inspired designs enables seamless integration into any interior style.



# Key features



## Waterresistant

SPC vinyl flooring is waterproof, which allows it to be used in the bathroom or kitchen. It is recommended that the floor be glued in these places.

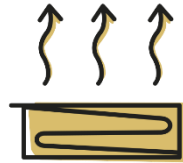

## Underfloor heating

SPC vinyl flooring can be installed in rooms with a water-based underfloor heating system.



## Scratch resistant

The floor offers exceptional durability - is stain and scratches resistant, even in high-traffic areas like hallways where muddy shoes and sand are frequently brought in.



## Anti-slip

The SPC vinyl floor has an R9/ R10 anti-slip certificate. It means that we can safely walk on it even when our feet are wet after leaving the bath.



## 4-side micro V-groove

The four-sided micro-bevel in vinyl planks enhances the natural look of the floor. The subtle bevel improves aesthetics, hides joints and protects edges from damage, ensuring durability



# Decors – NEW, 2024



Lark Oak  
4mm x 182mm x 1220mm



Pure Oak  
4mm x 182mm x 1220mm



Sand Oak  
4mm x 182mm x 1220mm

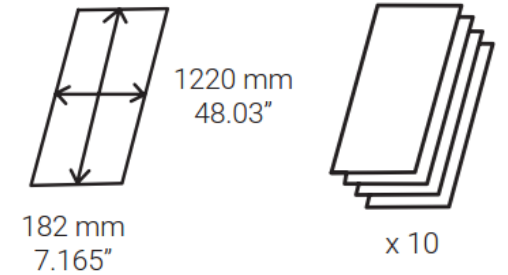

Pacific Oak  
4mm x 182mm x 1220mm



Honey Oak  
4mm x 182mm x 1220mm



Rock Oak  
4mm x 182mm x 1220mm

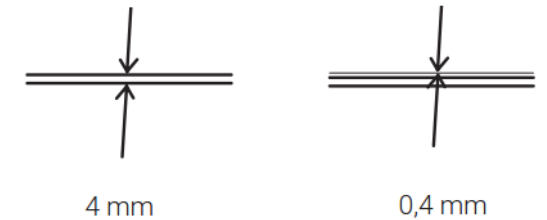

# Decors



Oak Royal  
4mm x 181mm x 1218mm



Oak Old  
4mm x 181mm x 1218mm



Oak Classic  
4mm x 181mm x 1218mm



Oak Light  
4mm x 181mm x 1218mm



Oak Grey  
4mm x 181mm x 1218mm

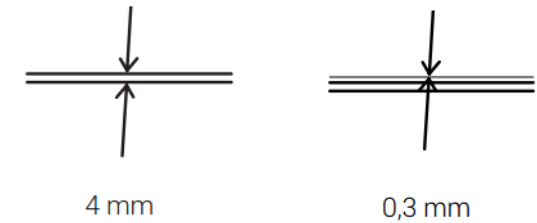
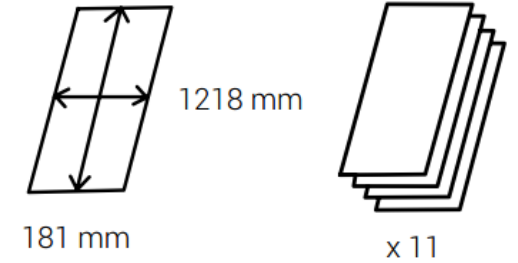

# Decors



Oak Noble  
4mm x 181mm x 1218mm



Oak Natur  
4mm x 181mm x 1218mm



Oak Desert  
4mm x 181mm x 1218mm



Oak Brown  
4mm x 181mm x 1218mm



Oak Dusty  
4mm x 181mm x 1218mm

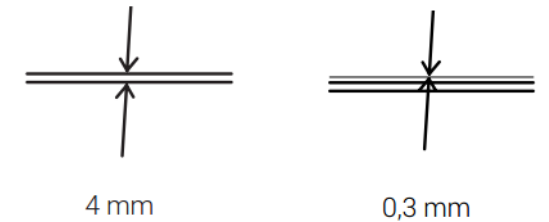
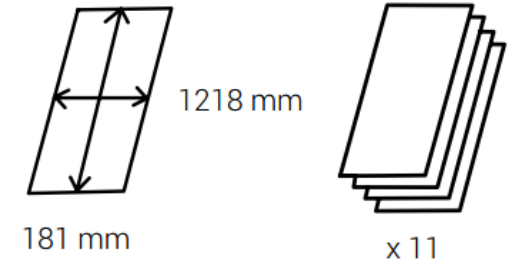



# Panel construction

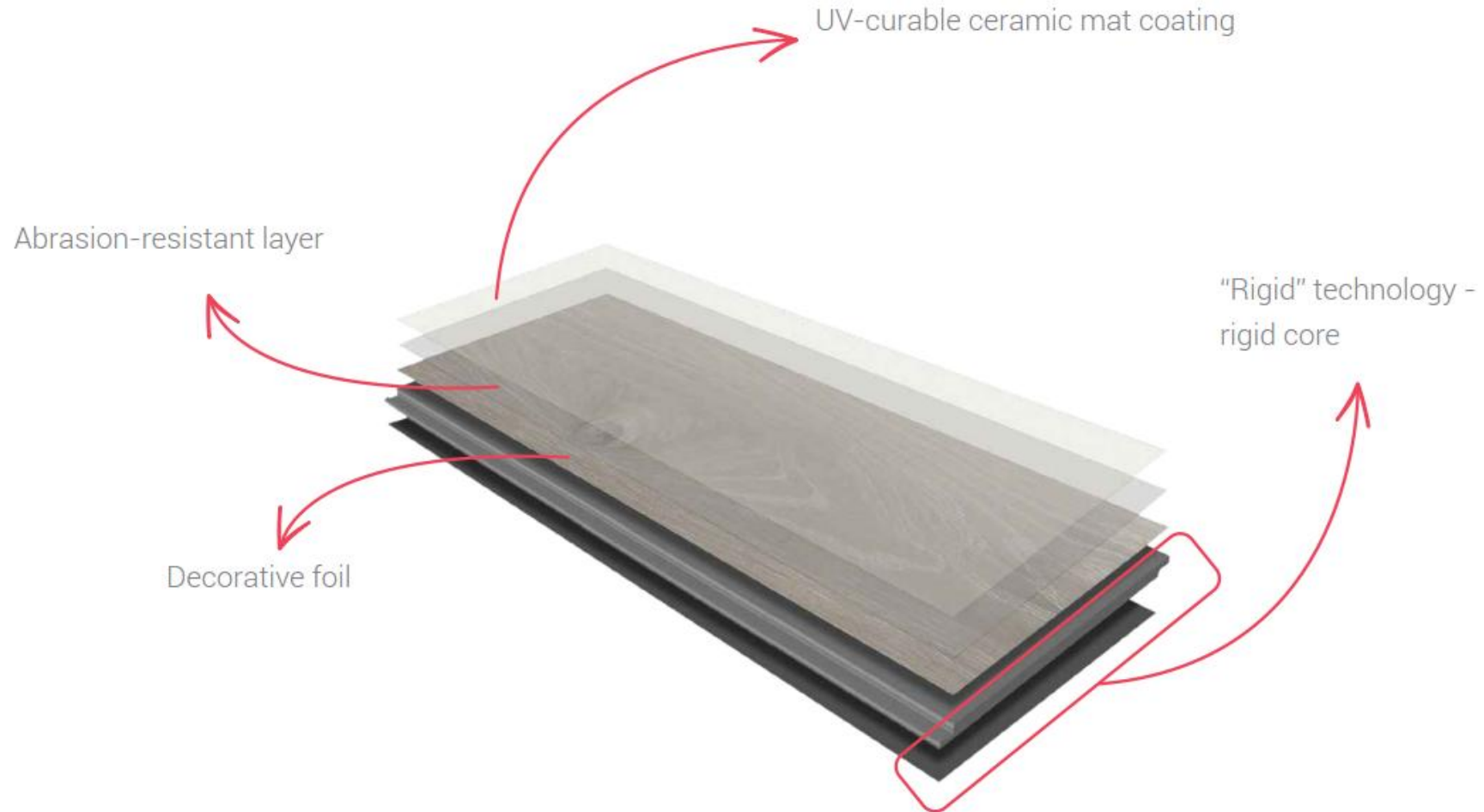

# Technical informations



## Packaging

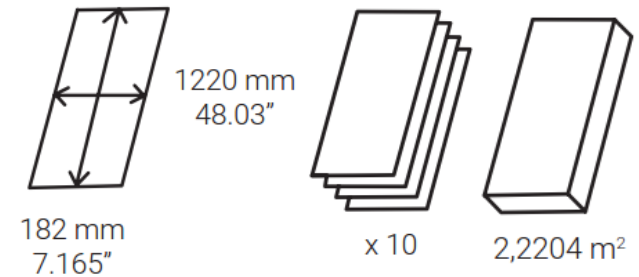
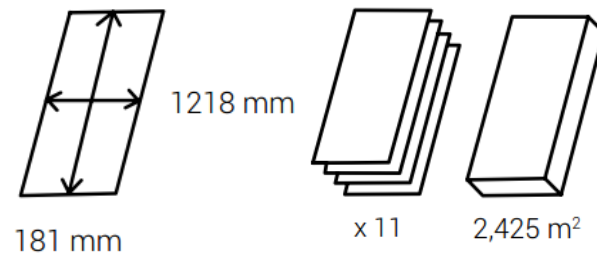



SPC Stone flooring

SPC (Stone Polymer Composite) Stone flooring combines aesthetic appeal with exceptional durability, thanks to its rigid mineral composite core and protective outer coating that repels moisture and dirt. Highly scratch-resistant and R10 anti-slip certified, it is ideal for high-traffic areas, bathrooms, and kitchens. Intuitive i4F drop-lock installation system of SPC Stone vinyl flooring ensures airtight joints, speeds up installation by 30%, and eliminates the need for expansion joints in large areas.



# Key features



## Waterresistant

SPC floor panels are suitable for installation in kitchens or bathrooms. They are completely waterproof and have R10 anti-slip certification.

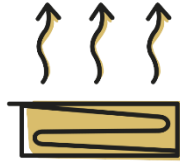

## Underfloor heating

SPC vinyl flooring can be installed in rooms with a water-based underfloor heating system.



## Abrasion resistant

The panels have a very high abrasion resistance (AC5/33) making them suitable for high traffic areas..



## Drop Lock system

The panels have an i4F connection (called drop lock). This is a very strong and rigid joint that allows SPC flooring to be installed without expansion joints in doors up to 10mb (100m2).



## 4-side micro V-groove

The micro V-groove create a natural look between planks. It reduces the visibility of dirt and dust in the joints.



---

# Decors



Calacatta Snow

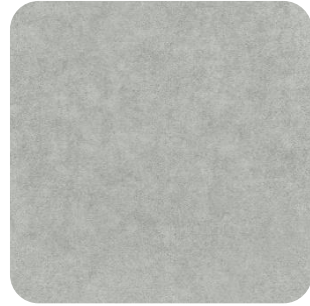

Concrete Light

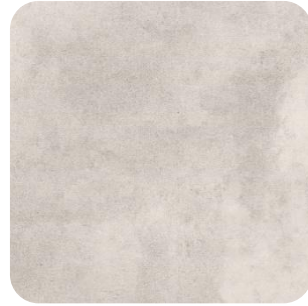

Concrete Dust



Concrete Beige



Rusty



Calacatta White



Ash Grey



Marble Skin



Dark Stone



Calacatta Black

# Technical informations

- UV-hardened wear layer
- Decorative layer – foil
- Rigid mineral core
- Vinyl layer

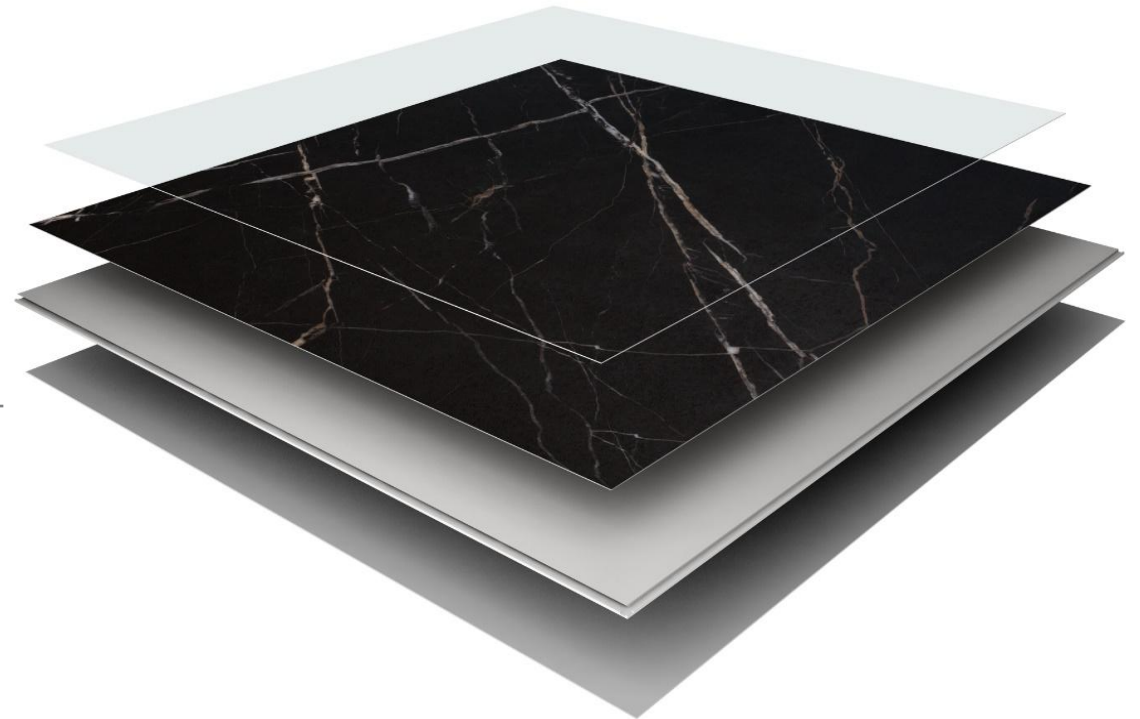
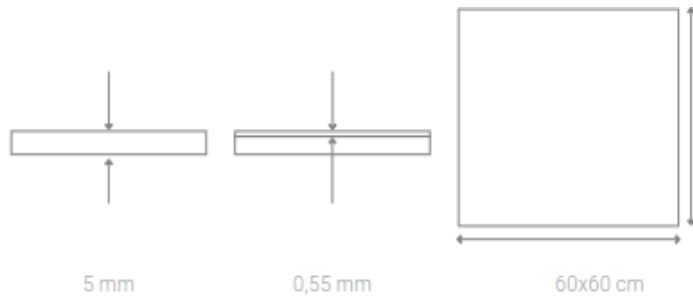



Skirting boards

# Skirting boards



Sempla



Linela



Esquero



Esquero Duo

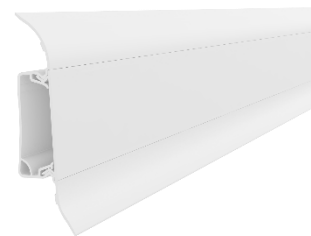

Izzi



Flex

Vilo skirting boards are a practical and aesthetic solution that is perfect for finishing off any interior. Thanks to simple installation systems, the process is quick and intuitive, requiring no specialized tools. Vilo skirting boards are available in a wide range of shapes and colours, making it easy to any style of interior, from homes to offices and commercial spaces. They combine durability with ease of use at an affordable price.



# Sempla

- An economical alternative to MDF skirting boards.
- Modern shapes in two heights: 65 mm and 80 mm.
- Classic rectangular and round shapes.
- Universal colours: white, black, shades of grey.
- Made of solid PVC, lightweight chamber construction.
- Made of recycled materials (<85% recyclates, depending on the production batch).
- Water resistant.
- Extremely resistant to damage and scratches.
- Finishing accessories for each model – ending caps.
- Mounted with glue directly to the wall.
- Easy to cut.



# Colours



701 White | 80 mm



704 Light Grey | 80 mm

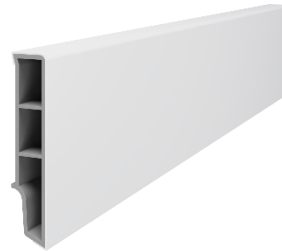

705 White | 65 mm



707 White | oval 65 mm



702 Black | 80 mm



703 Dark Grey | 80 mm



706 Black | 65 mm

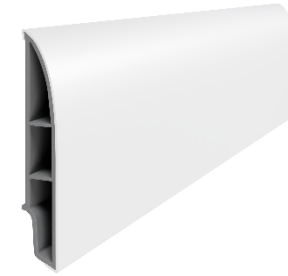

708 White | oval 80 mm

# Technical informations

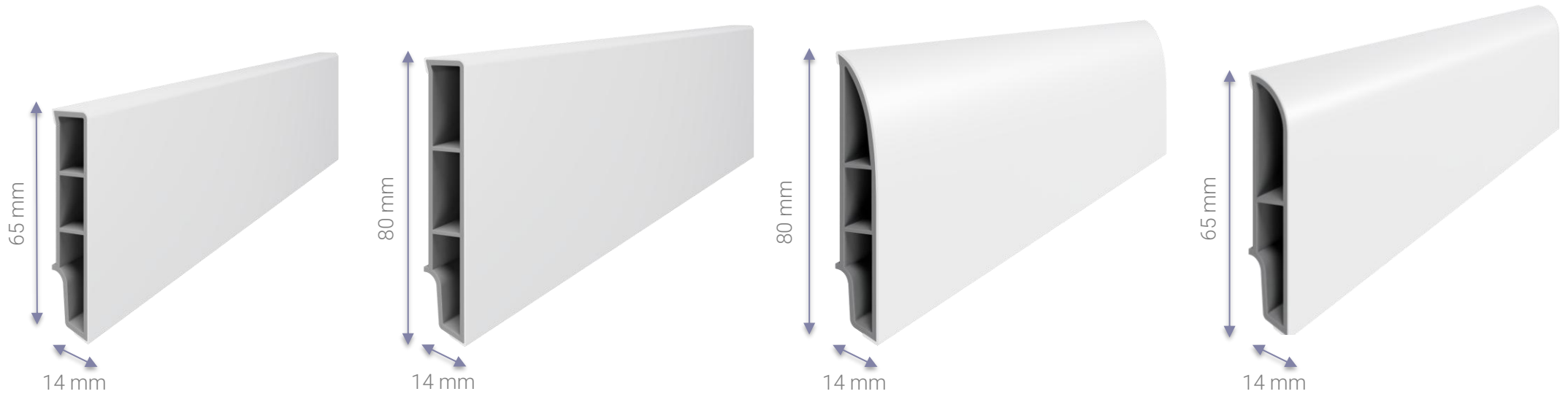

Length of Sempla shirting boards – 2400 mm

# Linela

- Non standard height – 8 cm.
- Slim shape allows to finish the space in a subtle way.
- Range of 15 colours – wooden and unicolours.
- Resistant to damage and scratches.
- Water resistant.
- Mounted with glue directly to the wall.
- Finishing accessories matched for each colour.



# Decors

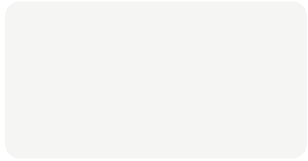

401 White



413 Light Grey



414 Grey



415 Anthracite



412 Black



411 Silver



409 Melton Oak



408 Brisbane Oak



404 Auckland Oak



405 Melbourne Oak



402 Wellington Oak



403 Hamilton Oak



406 Canberra Oak



407 Newcastle Oak



410 Adelaide Oak

# Technical informations

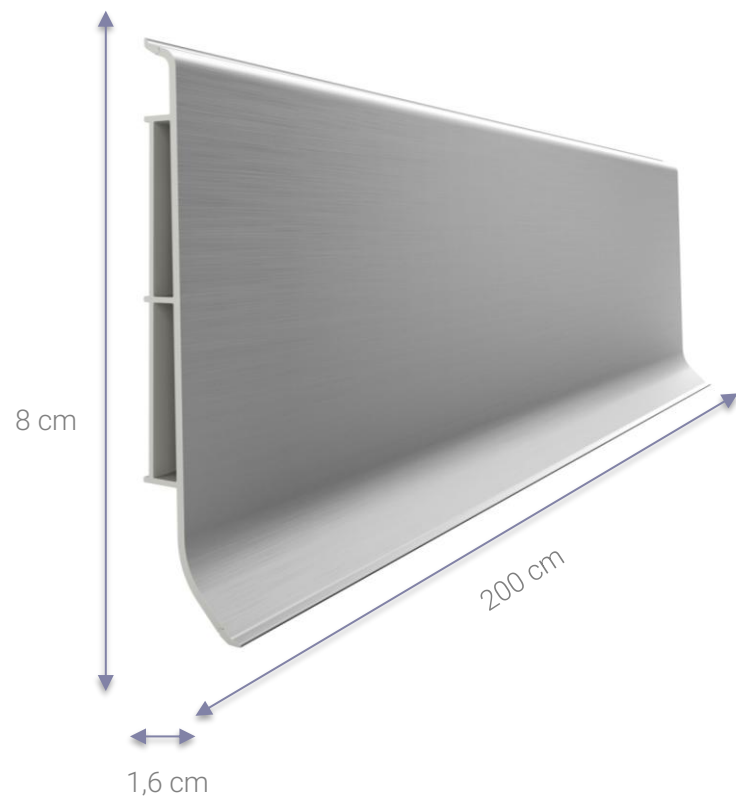

All colours of the skirting boards have perfectly matched accessories.

# Esquero

- Extremely durable and practical.
- Simple shape.
- Wide range of colours - 46 decors.
- Cable chamber.
- Moisture and impact resistant.
- Easy to keep clean.
- Quick and simple installation with a hammer plug.



# Decors

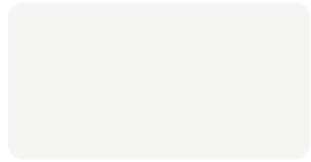

601



602



603



604



605



606



607



608



609



610



611



612



636



637



638



639



640



641



642



643



621



633



623

# Decors



680



681



682



683



684



685



686



687



688



689



690



691



627



622



620



626



631



625



629



632



628



632



644

## Technical informations

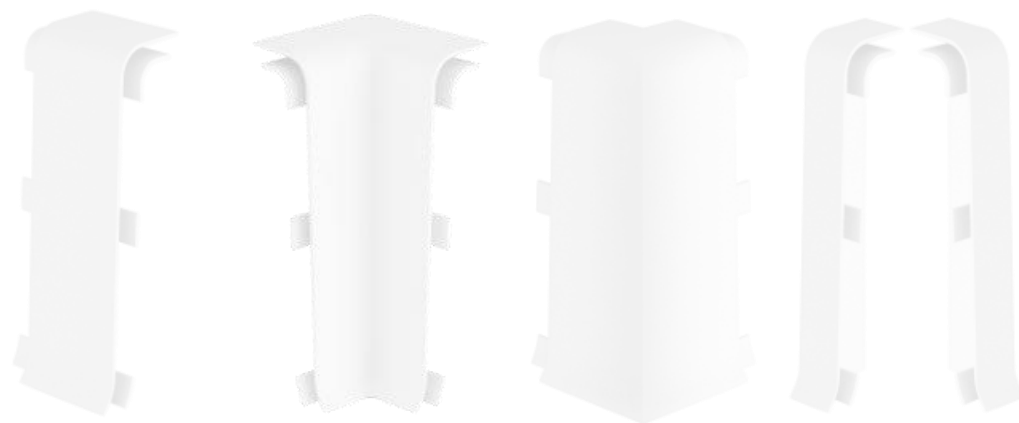
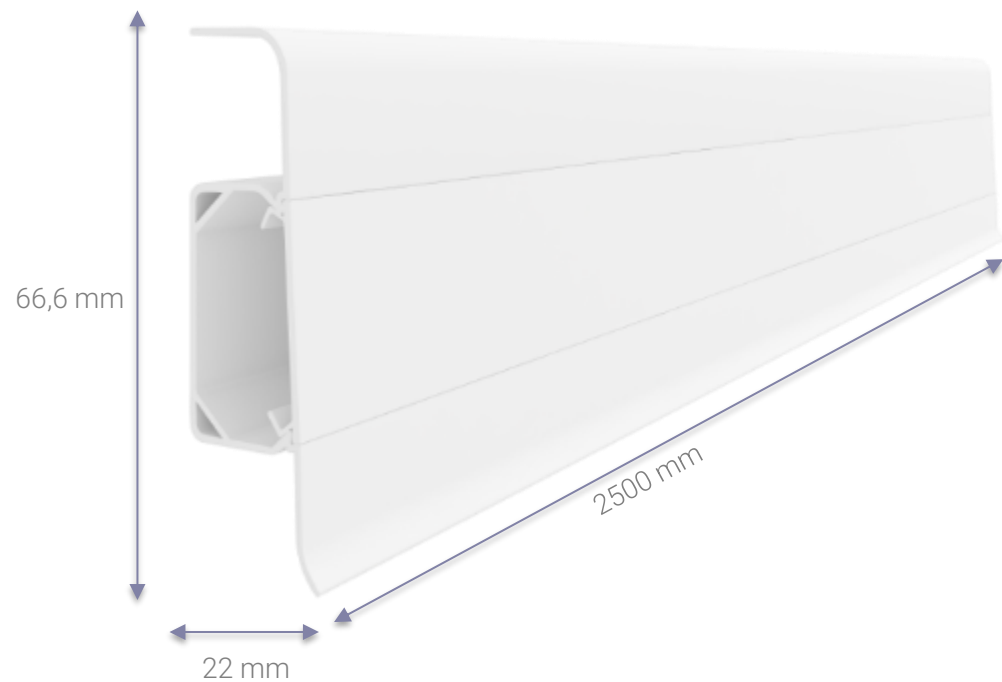

All colours of the skirting boards have perfectly matched accessories.

## Esquero Duo

- Extremely durable and practical.
- Simple shape, small height.
- Range of most popular colours - 14 decors.
- Cable chamber.
- Moisture and impact resistant.
- Easy to keep clean.
- Quick and simple installation with a hammer plug.



# Decors



622



663



652



653



654



655



656



657



658



659



660



661

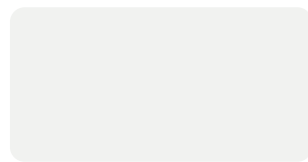

650



651

# Technical informations



All colours of the skirting boards have perfectly matched accessories.

# Izzi

- Traditional shape.
- Wide range of colours - 27 decors.
- Cable chamber.
- Flexible upper part allows the wall to be painted without removing the skirting board.
- Moisture resistant.
- Easy to keep clean.
- Quick and simple installation with a hammer plug.



# Decors



721



728



730



734



746



750



758



759



760



779



762



763



771



788

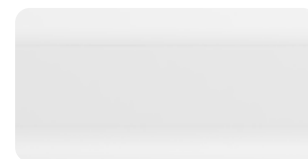

7113

# Decors



773



778



761



774



7108



7109



7110



7111



7112



7121



7122



7123

# Technical informations

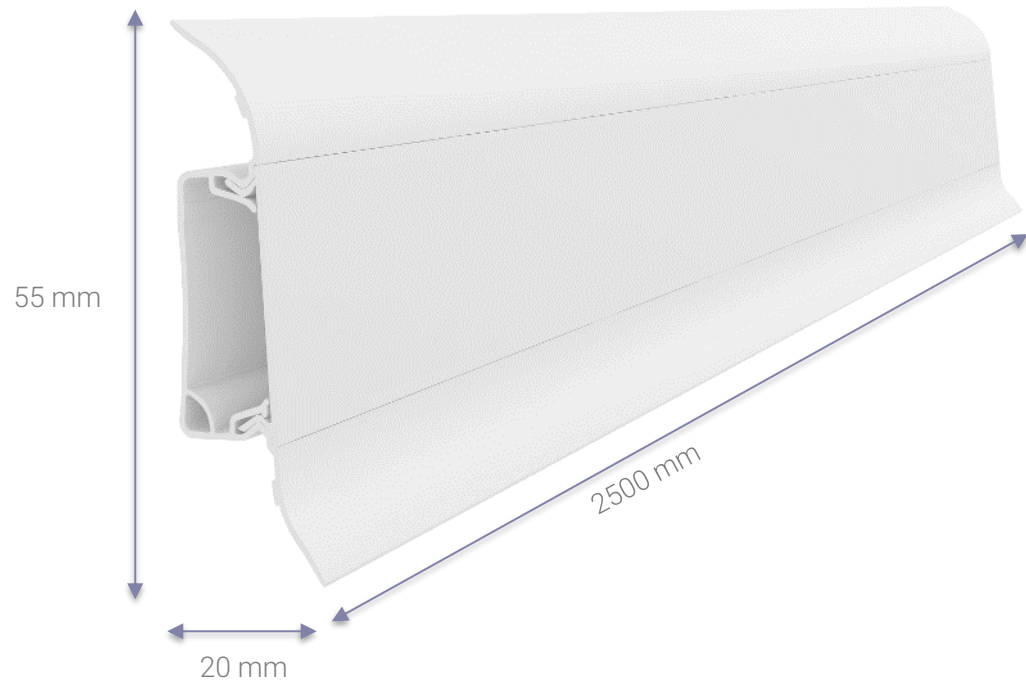

All colours of the skirting boards have perfectly matched accessories.

# Flex

- Traditional shape.
- Wide range of colours - 46 decors.
- Cable chamber.
- Moisture resistant.
- Easy to keep clean.
- Quick and simple installation with a hammer plug.



# Decors



504



508



518



521



524



529



530



533



543



544



582



584



585



5101



5102



5118



5103



5104



5105



5119



5106



5107



5114

# Decors

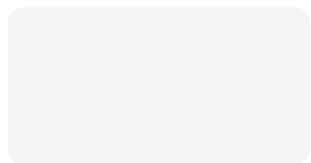

501



5115



5117



503



588

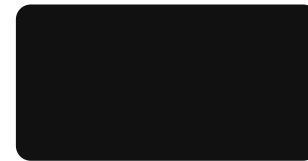

517



545



535



546



550



507



575



562



560



574



5134



5135



5136



5137



5138



5139

## Technical informations



All colours of the skirting boards have perfectly matched accessories.

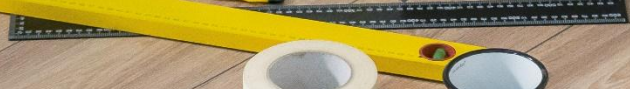

Underlays



The underlay for flooring panels is an integral part of any flooring system, directly influencing its durability, functionality, and user comfort. Its primary functions include leveling the subfloor, protecting panels from mechanical damage, reducing noise, and providing thermal insulation. Selecting the appropriate underlay ensure stability, minimize the risk of deformation, and enable the efficient use of underfloor heating systems, making them an indispensable element in professional finishing projects.



# Rigid Master | 1 mm

For SPC | rigid | LVT Flooring

## Material: PU

- underlay in a roll
- surface – PET foil, underneath - interlining
- density – 1200 kg/m<sup>3</sup>
- CS: >750 kPa
- DL (dynamic load): 3 500 000 cycles
- suitable for underfloor heating

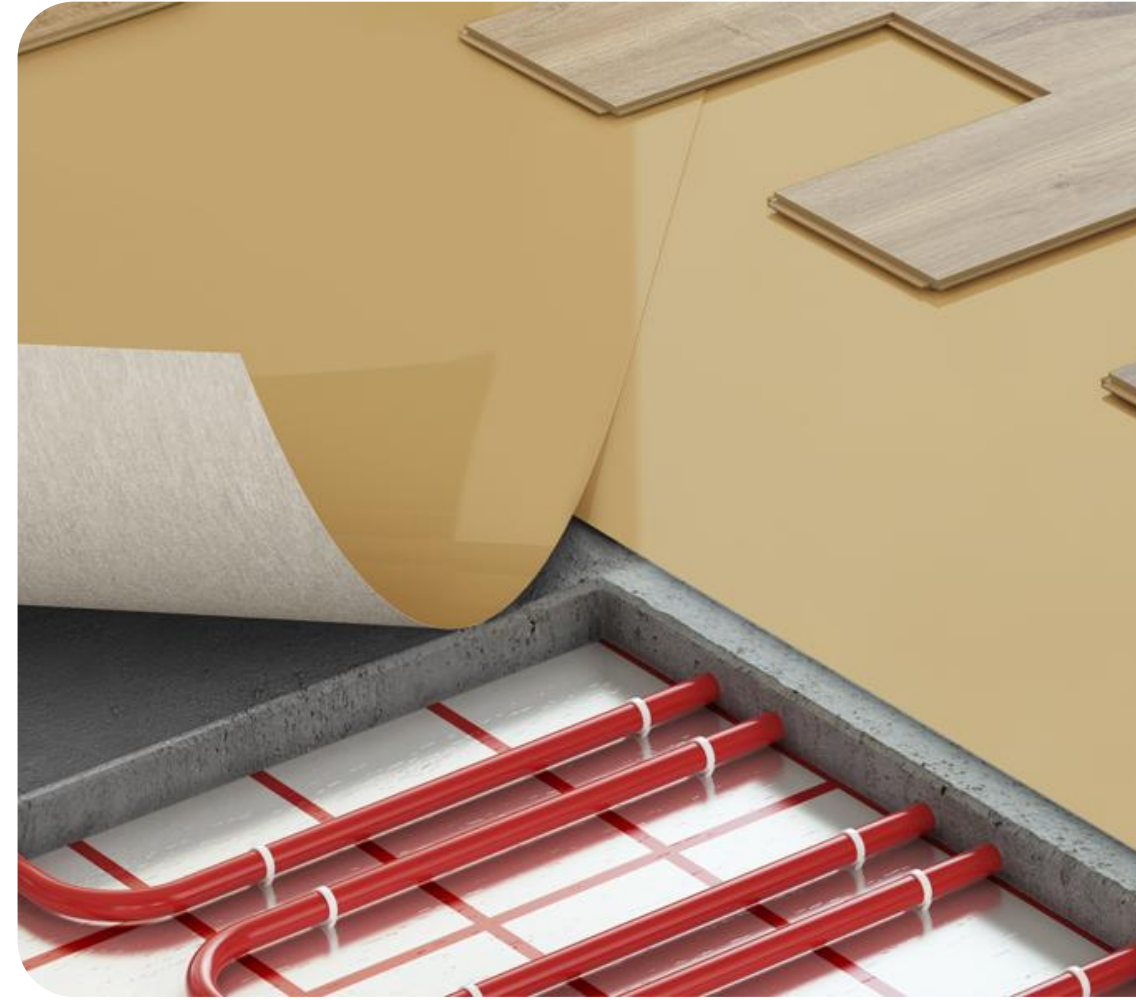
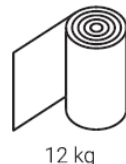
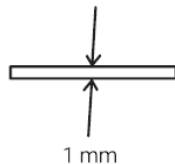
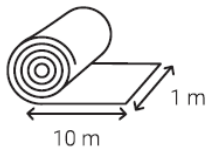

# Alu Multi Force | 1,5 mm

## Material: PU

- underlay in a roll
- surface – ALU foil, underneath - interling
- density: 1000 kg/m<sup>3</sup>
- CS >500 kPa
- DL (dynamic load): 3 000 000 cycles
- reaction to fire: Bfl-s1
- suitable for underfloor heating

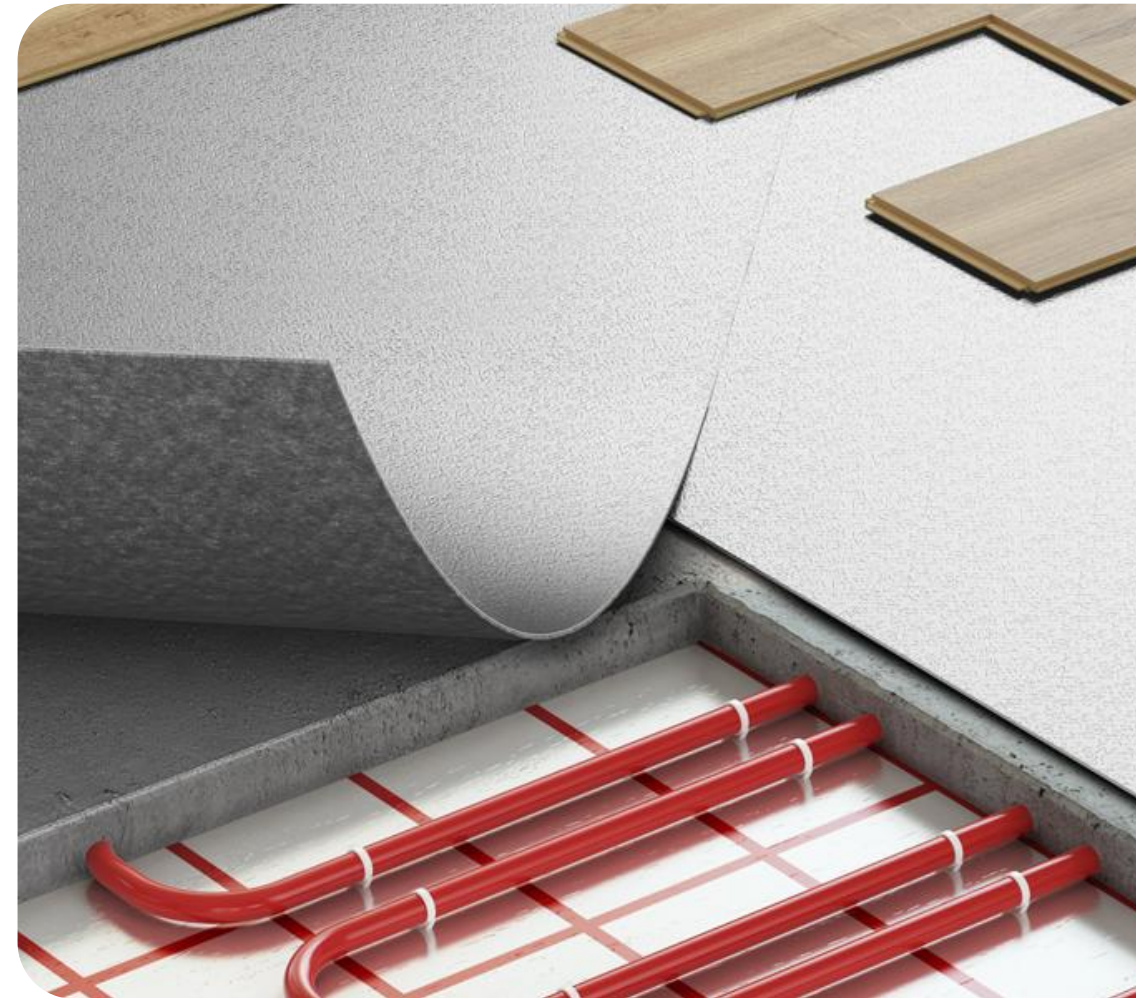
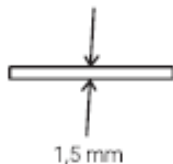
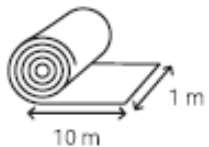

# Alu Pro | 2 mm

## Material: polyethylene

- floor underlay in a roll
- fast installation tape
- integrated vapour barrier
- suitable for underfloor heating

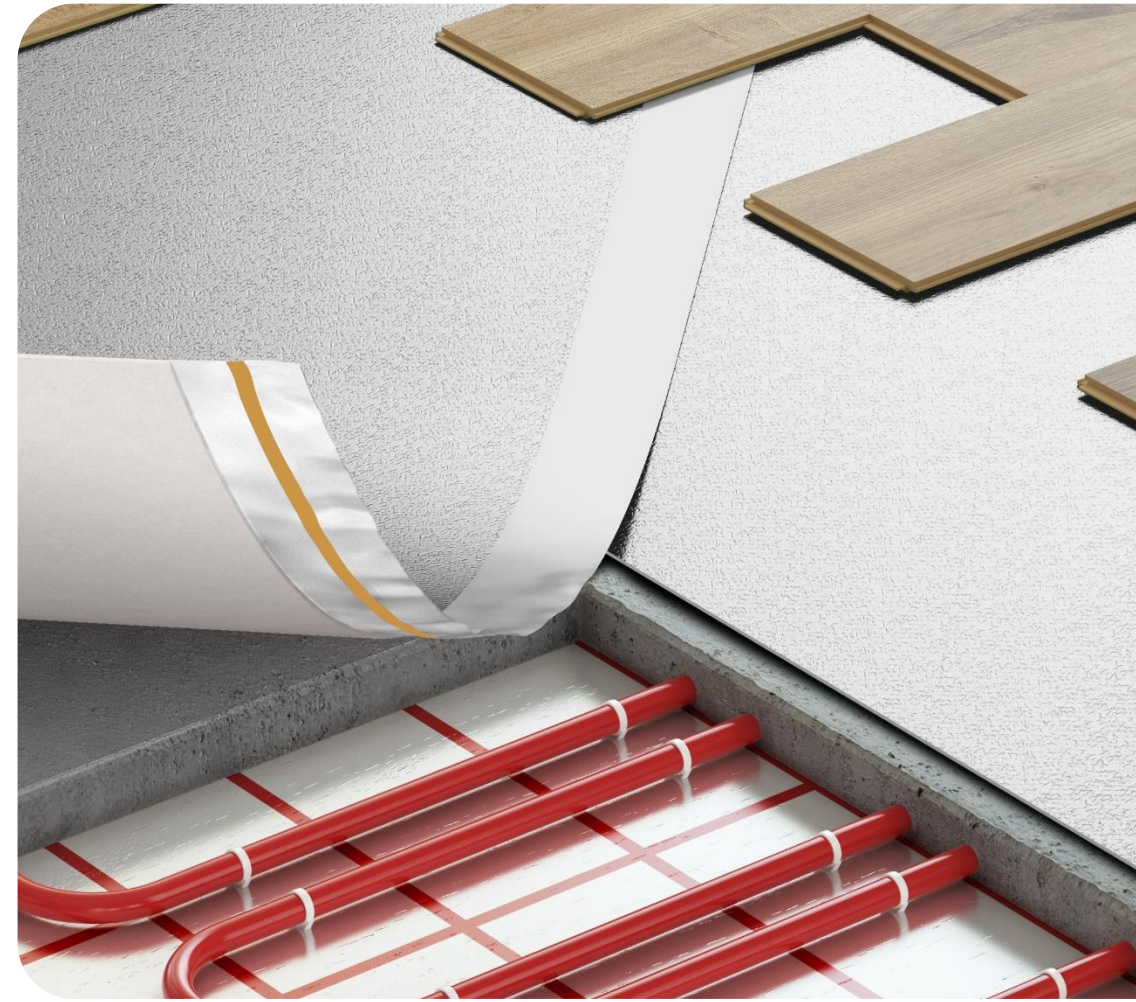
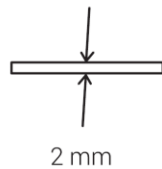
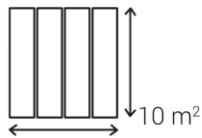
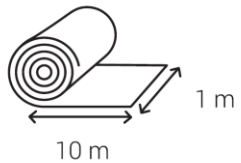

# Express | 3 mm

## Material: XPS

- accordion underlay with integrated aluminium foil
- an excellent barrier against fungi and mold
- intuitive, extremely fast assembly

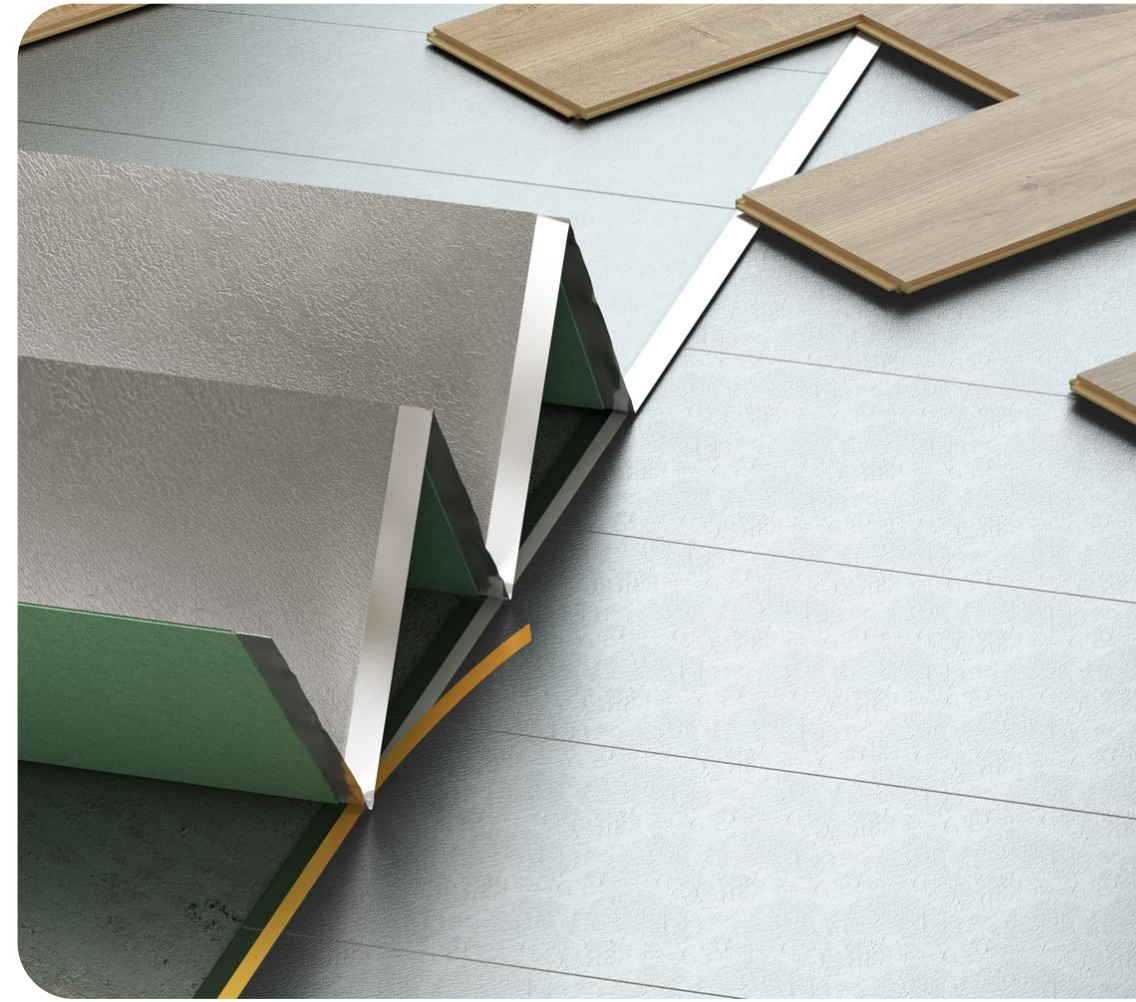
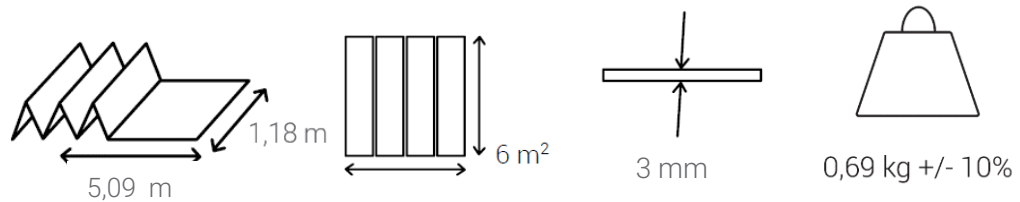

# Express | 2 mm

## Material: XPS

- accordion underlay with integrated aluminium foil
- an excellent barrier against fungi and mold
- intuitive, extremely fast assembly

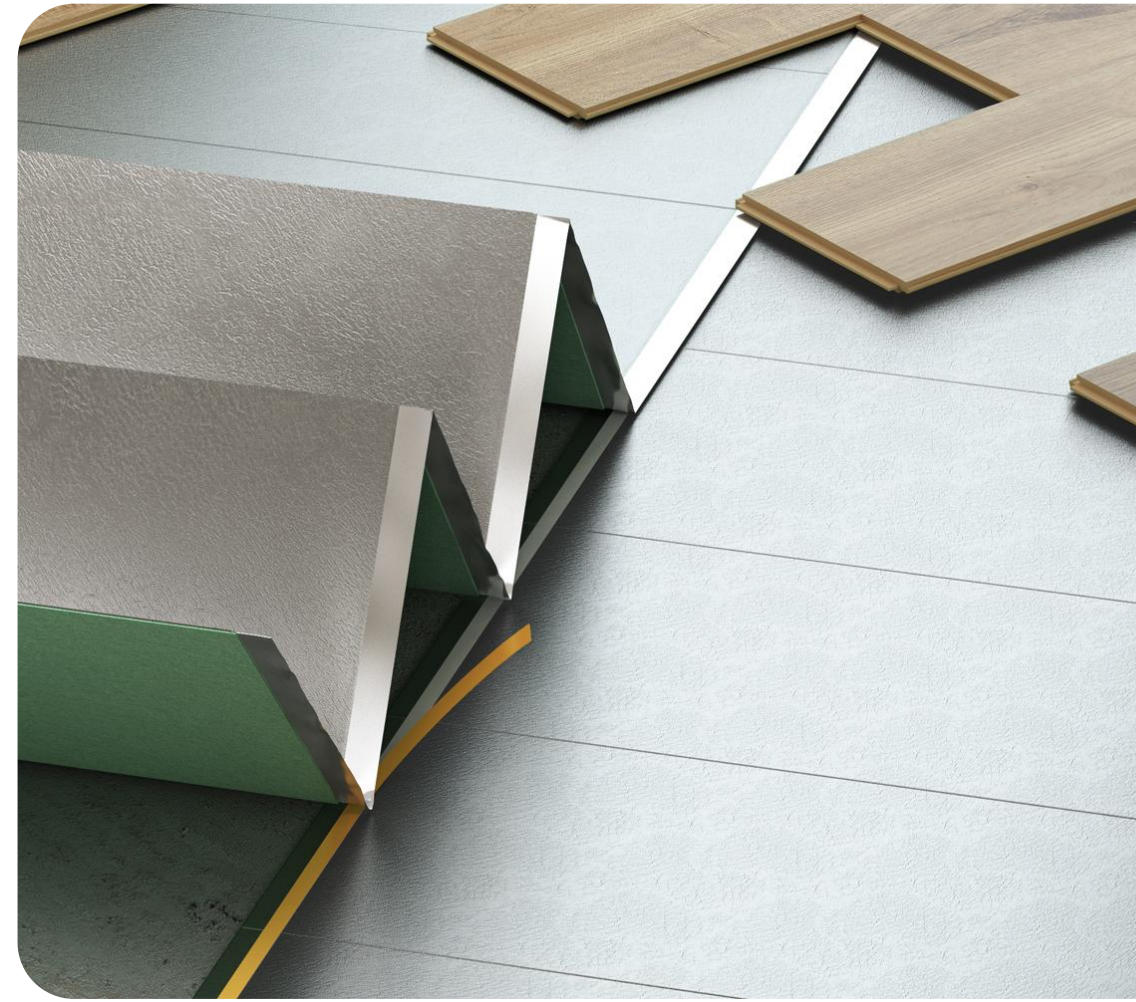
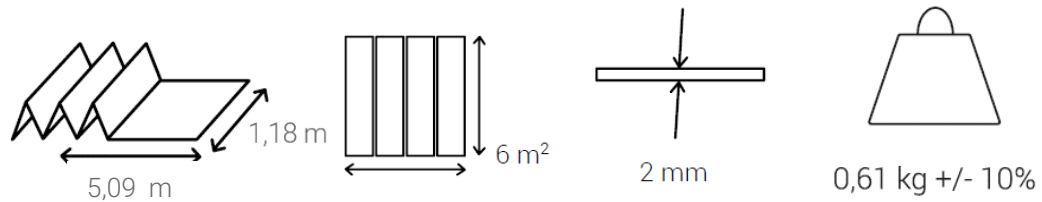

## Underlay for flooring panels | 3 mm

### Material: Extruded polystyrene XPS

- board mat underlay
- levels unevenness in the floor
- Intuitive and quick installation

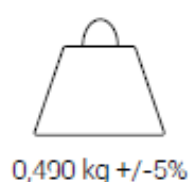
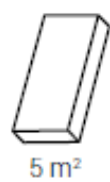
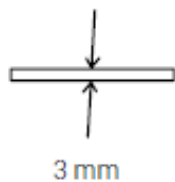
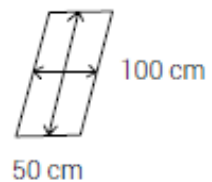

## Underlay for flooring panels | 5 mm

### Material: Extruded polystyrene XPS

- board mat underlay
- levels unevenness in the floor
- Intuitive and quick installation

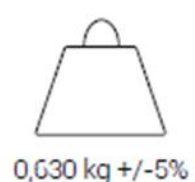
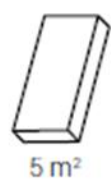
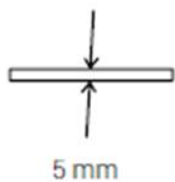
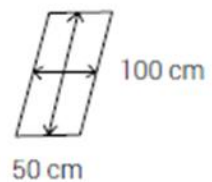

## Underlay for Floorboards | 5 mm puzzle

### Material: Extruded polystyrene XPS

- puzzle board mat underlay
- levels unevenness in the floor
- Intuitive and quick installation

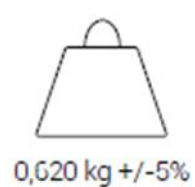
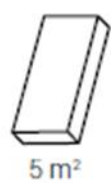
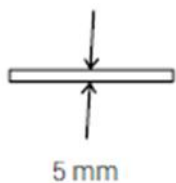
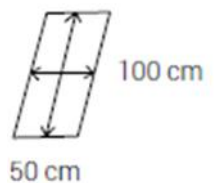

# Underlay for flooring panels | 2 mm roll

## Material: Extruded polystyrene XPS

- board mat underlay
- levels unevenness in the floor
- Intuitive and quick installation

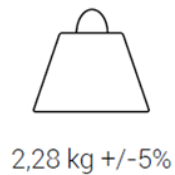
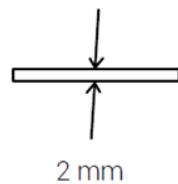
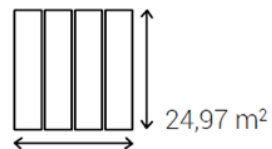
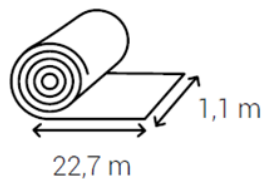

# Underlay for flooring panels | 2 mm roll

## Material: Extruded polystyrene XPS

- Openwork board mat underlay
- levels unevenness in the floor
- Intuitive and quick installation

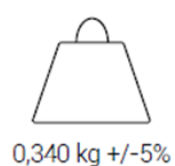
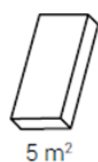
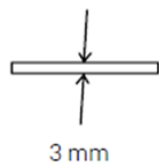
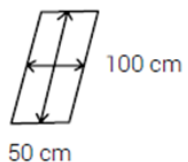
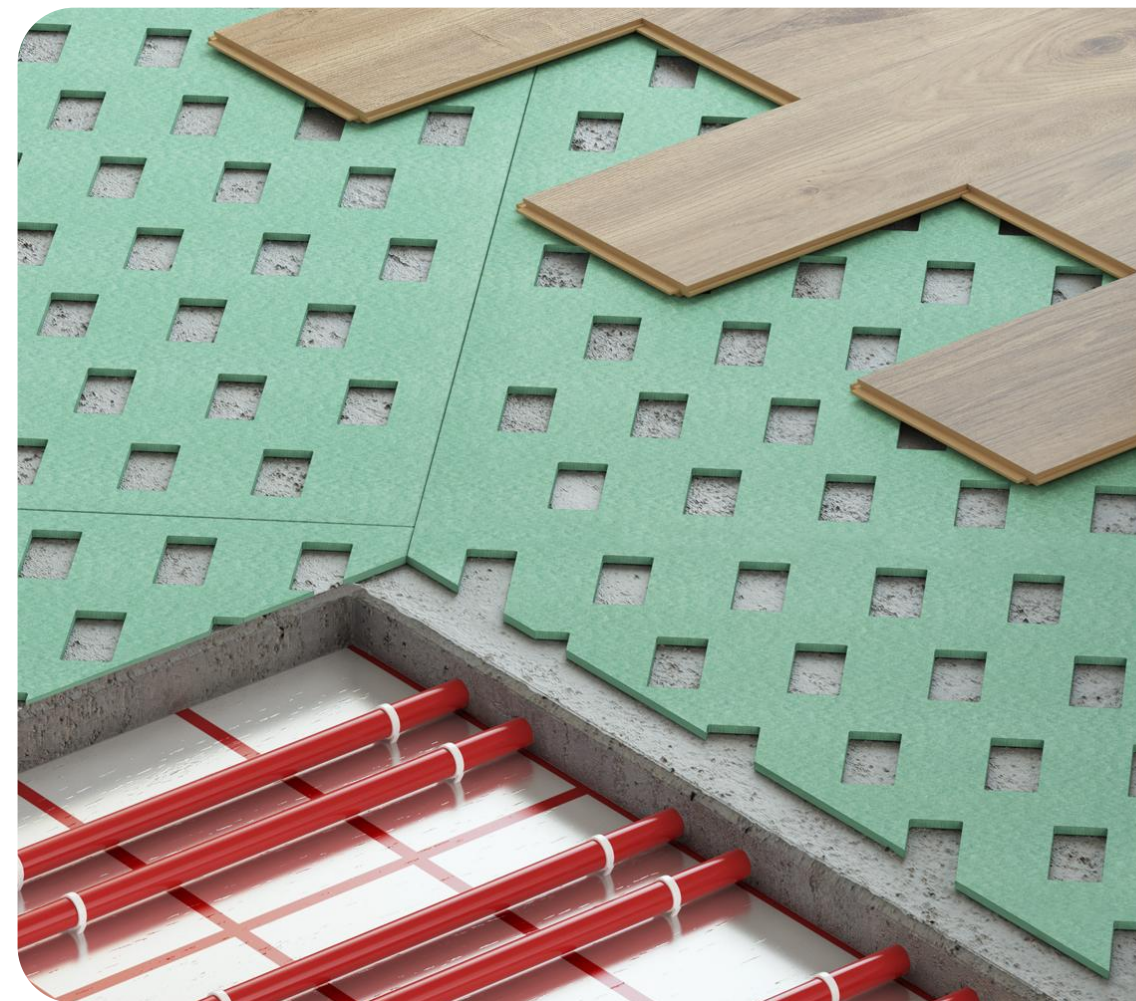

## Technical information - summary

NAME	SIZE	MATERIAL	FORM	LEVELING UNEVENNESS	ACOUSTIC ISOLATION	LOAD RESISTANCE	HEAT CONDUCTION	FLOOR HEATING
Express SPC 1,5 mm		XPS	accordion			>750 kPa		yes
Rigid Master 1 mm	1 x 10 m	PU	roll	~ 0.2 mm	Up to 14 dB	>750 kPa	0.01 m <sup>2</sup> K/W	yes
Alu Multi Force 1,5 mm	1 x 10 m	PU	roll	~ 0.6 mm	Up to 16 dB	> 500 kPa	0.01 m <sup>2</sup> K/W	yes
Alu Pro 2 mm	1 x 10 m	polyethylene	roll	1,55 mm	>18 dB	10 kPa	0,050 m <sup>2</sup> K/W	yes
Express 2 mm	1,18 x 5,1 m	XPS	accordion	1,5 mm	>19 dB	90 kPa	0,08 m <sup>2</sup> K/W	yes
Express 3 mm	1,18 x 5,1 m	XPS	accordion	2,9 mm	> 20 dB	90 kPa	0,11 m <sup>2</sup> K/W	yes
Underlay 3 mm	0,5 x 1 m	XPS	board	≥ 1,5 mm	≥ 19 dB	≥ 65 kPa	0,032 m <sup>2</sup> K/W	no
Underlay 5 mm	0,5 x 1 m	XPS	board	≥ 4 mm	≥ 19 dB	≥ 65 kPa	0,032 m <sup>2</sup> K/W	no
Underlay 5 mm puzzle	0,5 x 1 m	XPS	puzzle	≥ 4 mm	≥ 19 dB	≥ 65 kPa	0,032 m <sup>2</sup> K/W	no
Underlay 2 mm	1,1 x 22,7 m	XPS	roll	≥ 1,5 mm	≥ 19 dB	≥ 35 kPa	0,032 m <sup>2</sup> K/W	no
Underlay 3 mm openwork	0,5 x 1 m	XPS	board	≥ 2 mm	≥ 19 dB	≥ 30 kPa	0,032 m <sup>2</sup> K/W	yes



Facades and soffit



Fronto slat panels



Vinyl siding



Soffit

A photograph of a modern building's exterior. The central feature is a glass door with a dark frame, set within a wall of vertical wood slat panels. To the right, a white wall with a dark window frame is visible. The foreground includes a paved walkway, a planter box with green grass and purple flowers, and a young tree. The sky is blue with light clouds.

Fronto slat panels

Fronto slat panels are a modern solution for exterior design. They provide an aesthetic finish to facades and soffits, creating a 3D effect with joints and light-shadow interplay. The panels are highly resistant to mechanical damage and UV radiation, preventing discolouration and deformation. Lightweight and easy to install, they don't require special maintenance. Can be installed vertically or horizontally to match the style of the building. Available in wood-like colours, with or without dark joints, they perfectly combine durability with elegance.



# Key features



## Water resistance

The panels are completely waterproof. They do not require sealing, do not absorb moisture, and when properly installed, they ensure ventilation of the walls.



## Easy installation

Installation of the panels does not require the use of special tools. The CLICK system used ensures proper connection of the panels.



## No maintenance

Fronto panels are a finished product - there is no need for painting, sealing or maintenance, which means lower cost and no environmental damage.



## Horizontal and vertical installation

The panels can be installed in a variety of ways: vertically or horizontally, on the wall or ceiling.



## Design

Perfect reflection of the color and grain of the wood. Thanks to the use of modern digital printing technology, the panels have a matte finish



# Decors



Golden Oak



Oak Winchester



Oak



Honey Oak



Walnut



Golden Oak V-Black



Light Oak V-Black



Oak V-Black



Walnut V-Black

---

## Decors



Buttercream



Light Olive



Anthracite Grey \*

\* Anthracite Gray colour can be installed only in shaded places.



## Modern solutions

1. The **hurricane proof lock** ensures better adhesion of the panels to the façade and eliminates the noise the panels make in high winds.
2. The **Click lock** allows the panels to be joined quickly and securely, making installation easier.
3. Mounting holes speed up installation.
4. The **self-cleaning structure** reduces the build-up of dirt and dust, making it easier to keep the façade clean.

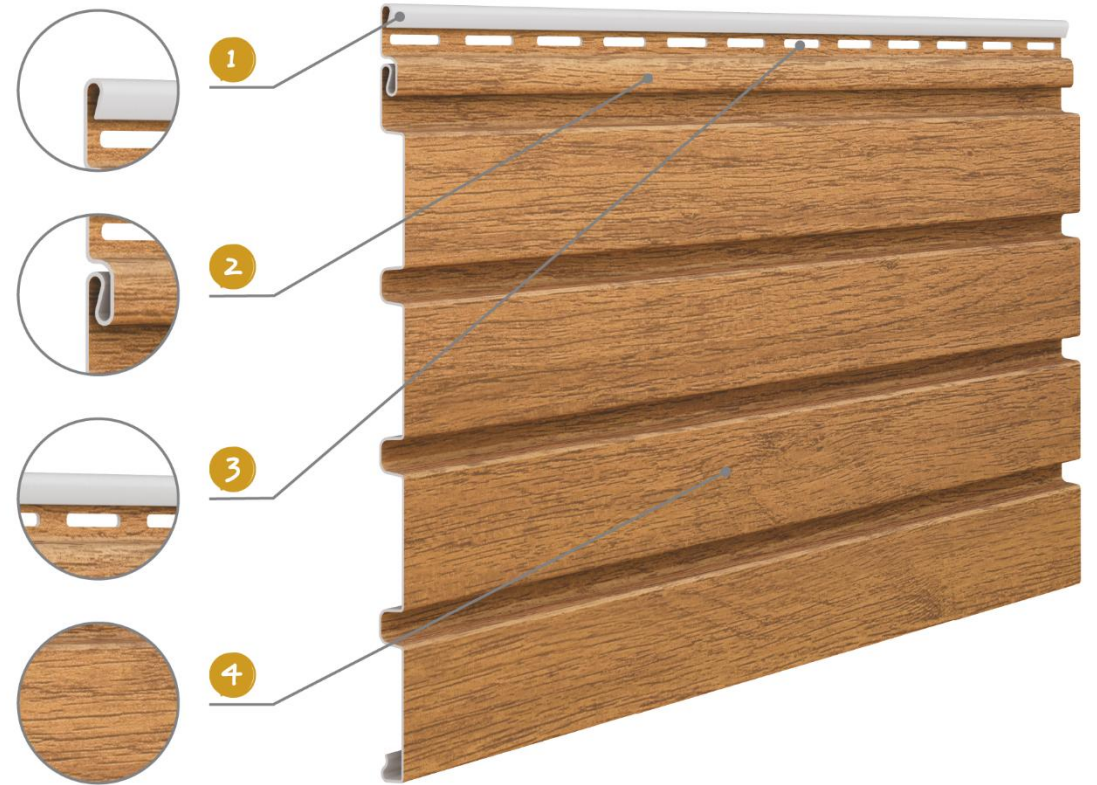

# Technical informations

## Slat panel SV(P) 06



## Dimensions

- Panel type: slat panels
- Length: 2,95 m
- Width (usable): 250 mm
- Width (total): 283 mm

## Finishing trims

- All trims are available in the colours of the Fronto panels
- Length of the trims: 3,05 m

# Finishing trims

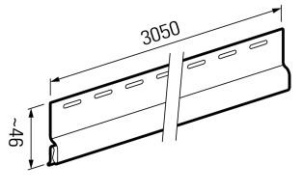

SV 11  
Starting trim

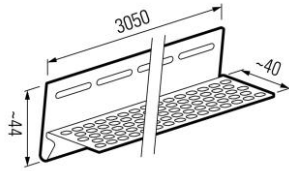

SV 11.5  
Bottom ventilation trim

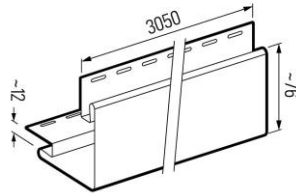

SV (P) 12  
Outside corner

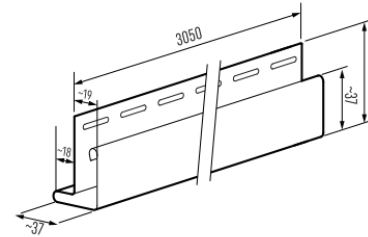

SV (P) 12.5  
Outside corner mini

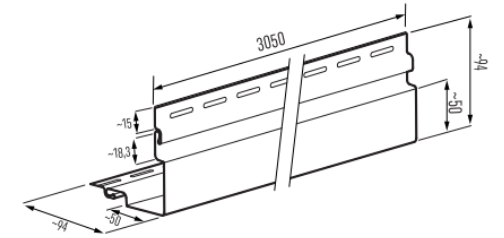

SV (P) 12V Outside corner  
for vertical installation

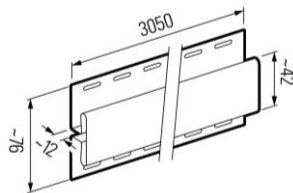

SV(P) 18  
Connector

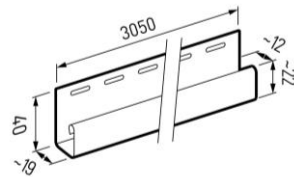

SV(P) 15  
J-trim

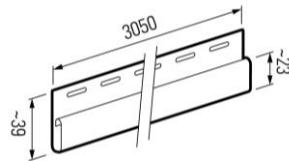

SV(P) 14  
Finishing trim

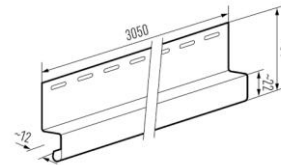

SV(P) 16.5  
Drip edge

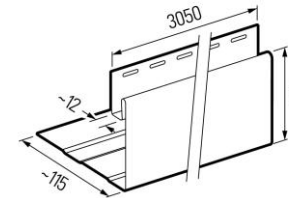

SV 17  
Facade flashing small

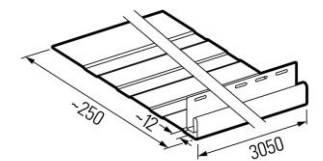

SV(P)19  
Facade flashing large



Vinyl siding

---

Vinyl siding is an excellent solution for building façades. It looks aesthetically pleasing, lasts for years, and is resistant to changing weather conditions. This product does not require additional care or refreshing works during its use. It is available on the SV(P) 05 flat panel and on the SV 03 double bevelled, in plain and wood-like colours. That way, it is possible to adapt the product to any architectural style. The panels can be used as a complete façade finish. They will also work well with elements covered with classic plaster, brick or stone.



# Key features



## Water resistance

The panels are completely waterproof. They do not require sealing, do not absorb moisture, and when properly installed, they ensure ventilation of the walls.



## Easy installation

Installation of the panels does not require the use of special tools. The CLICK system used ensures proper connection of the panels.



## No maintenance

The product is made of durable material – it requires no maintenance during use.



## Good price

The panels can be installed in a variety of ways: vertically or horizontally, on the wall or ceiling.



## Wooden Design (SVP05)

The shape, colour, and texture perfectly imitate straight, wide wooden planks. Facade maintains its colour and good appearance over the years - no peeling or delamination.



## Decors SV(P) 05



Balance Oak



Honey Oak



Oak Winchester



Golden Oak



Polar Oak

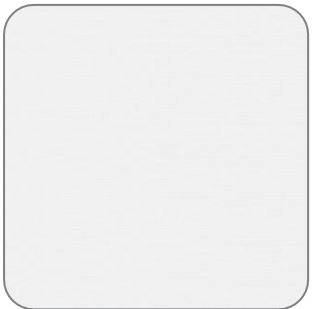

White

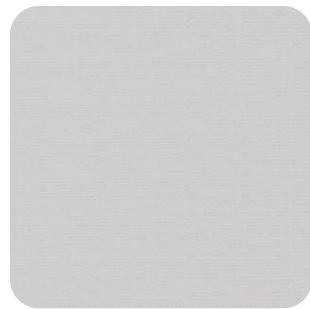

Light Grey

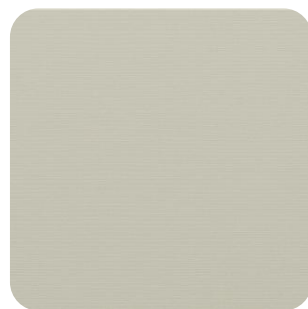

Light Olive

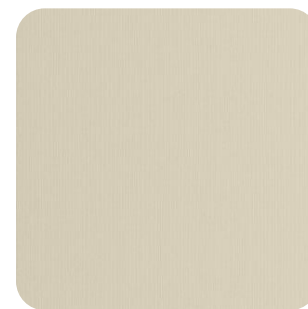

Buttercream

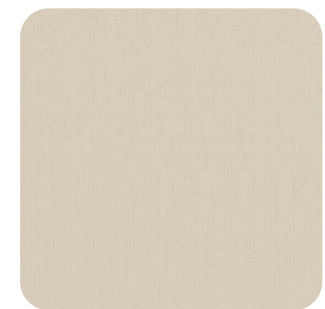

Beige

## Modern solutions of SV(P) 05

1. The **hurricane proof lock** ensures better adhesion of the panels to the façade and eliminates the noise the panels make in high winds.
2. The **Click lock** allows the panels to be joined quickly and securely, making installation easier.
3. Mounting holes speed up installation.
4. The **self-cleaning structure** reduces the build-up of dirt and dust, making it easier to keep the façade clean.



# Technical informations

## Flat panel SV(P) 05



## Dimensions

- Panel type: flat panel
- Length: 3 m / 3,85 (for order)
- Width (usable): 250 mm
- Width (total): 283 mm

## Finishing trims

- All trims are available in the colours of the Vinyl siding panels
- Length of the trims: 3,05 m



---

## Decors SV(P) 03



White

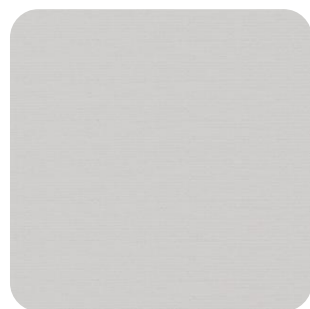

Light Grey

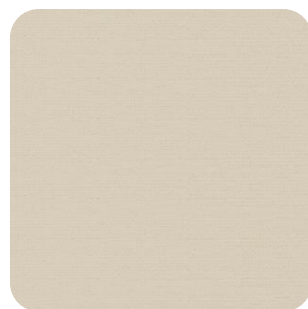

Beige

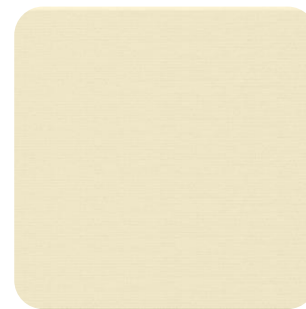

Cream

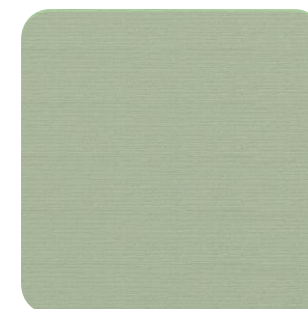

Light Green

# Technical informations

## Double - beveled panel SV 03

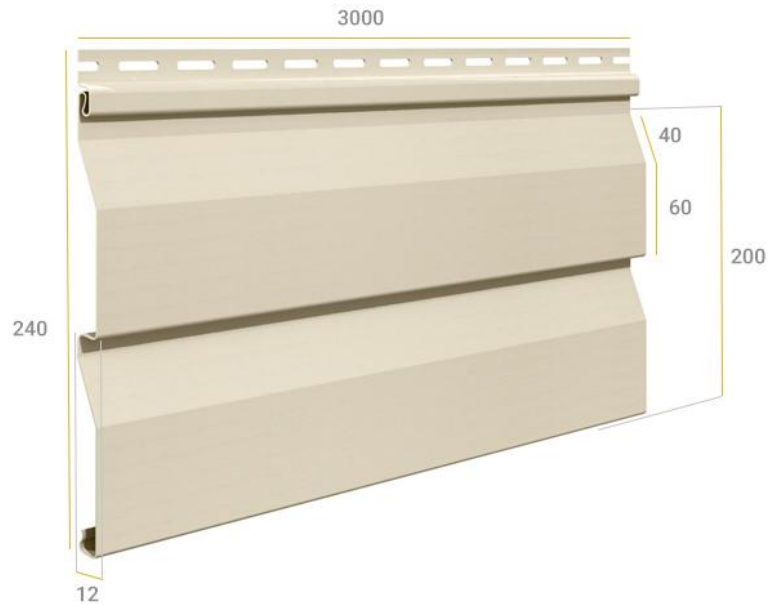

## Dimensions

- Panel type: double – beveled panel
- Length: 3 m
- Width (usable): 200 mm
- Width (total): 240 mm

## Finishing trims

- All trims are available in the colours of the Vinyl siding panels
- Length of the trims: 3,05 m

# Finishing trims

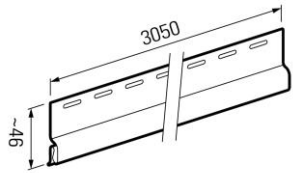

SV 11  
Starting trim

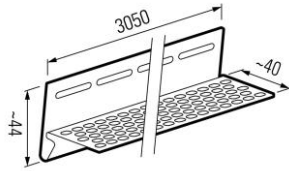

SV 11.5  
Bottom ventilation trim

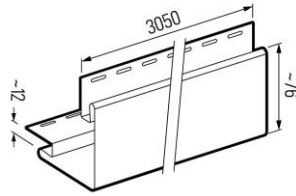

SV (P) 12  
Outside corner

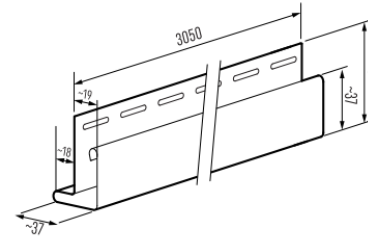

SV (P) 12.5  
Outside corner mini

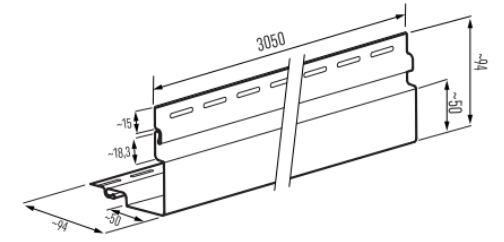

SV (P) 12V Outside corner  
for vertical installation (only for  
SV(P) 05)

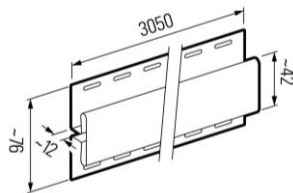

SV(P) 18  
Connector

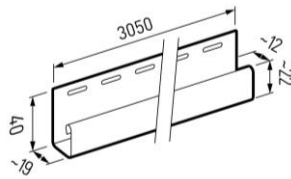

SV(P) 15  
J-trim

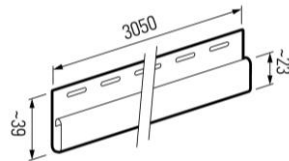

SV(P) 14  
Finishing trim

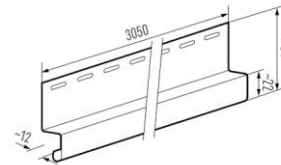

SV(P) 16.5  
Drip edge

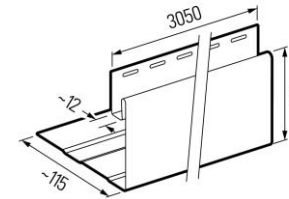

SV 17  
Facade flashing small

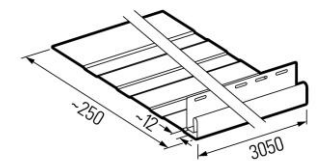

SV(P)19  
Facade flashing large

A modern outdoor patio area featuring a prominent wooden slat soffit. The patio is furnished with a light-colored wooden dining table, two chairs, and a bench. Large glass windows with dark frames are visible, reflecting the surrounding greenery and sky. The patio is bordered by a gravel strip and a well-maintained lawn with various plants and trees. The sky is blue with scattered white clouds.

Soffit

Vinyl roof soffit is a practical and hassle-free way to finish a roof on a daily basis. It requires no maintenance. It is quick and easy to install, resistant to changing climatic conditions and biological corrosion. Thanks to the use of perforations in the panels, it will ensure proper ventilation and protection of the roof. Soffit can also be used in shaded areas, such as terrace ceilings, balconies, or carports.



---

# Key features



## Water resistance

The panels are completely waterproof. They do not require sealing, do not absorb moisture, and when properly installed; they ensure ventilation of the walls.



## Easy installation

Installation of the panels does not require the use of special tools. The CLICK system used ensures proper connection of the panels.



## No maintenance

The product is made of durable material – it requires no maintenance during use.



## Good price

The panels can be installed in a variety of ways: vertically or horizontally, on the wall or ceiling.



## Ventilation

The soffit ensures proper roof ventilation, protecting from moisture, fungi, and mould. Perforated holes guard against insects like wasps, bumblebees, and hornets.



---

## Decors



White



Graphite



Brown



Oak Winchester



Golden Oak



Walnut

# Technical informations

Panel with perforation  
SV(P) 07



Panel without perforation  
SV(P) 08



## Dimensions

- length: 2,7 m / 3 m (for order)
- width (total): 340 mm
- width (usable): 300 mm

# Finishing trims

- The trims are available in the colours of the soffit panels
- Length of trims: 3,05 m

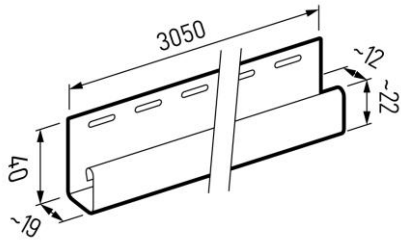

SV (P) 15 J-Trim

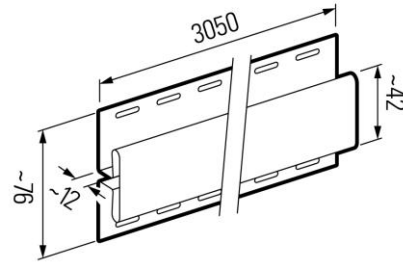

SV(P) 18 Connector



Thank you for your attention

14.01.2025